



AURATON 200 RT

Owner's manual ver. 20200323

The document contains information on the safety, assembly and use of the auraton 200 RT device

Wireless temperature controller

Thank you for purchasing the modern temperature controller based on an advanced microprocessor:
AURATON 200 RT.



FrostGuard function

Protects the interior from freezing.



Enables cyclic reduction of set temperature by 3°C for 6 hours.

LCD

Backlit LCD display

The backlit display enables device control even in dark rooms.

16A

Operation under the load of up to 16A/10A

The AURATON RT receiver is equipped with a relay capable of operating with the load of up to 16A/10A. Its low-sparking technique of switching mains voltage contributes to the low wear of relay contacts.

Optional system components



AURATON H-1

Window handle (sold separately)

A window handle, equipped with a position sensor and a transmitter, is an optional element of the system. This way the handle provides information about the state of the window. The handle also differentiates between 4 window positions: opened, closed, pivoted and trickle ventilated (micro-ventilation). The handle transmits information to the RT receiver that controls the relay, e.g. switching off a heater in the event of opening the window or lowering the temperature down to 3°C to conserve energy. One RT receiver operates with max 25 handles.

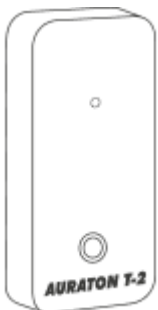

AURATON T-2

Thermometer (sold separately)

An optional element of the system allowing for controlling temperature in a room other than that with the AURATON 200 RT regulator.

Description of the AURATON RT receiver



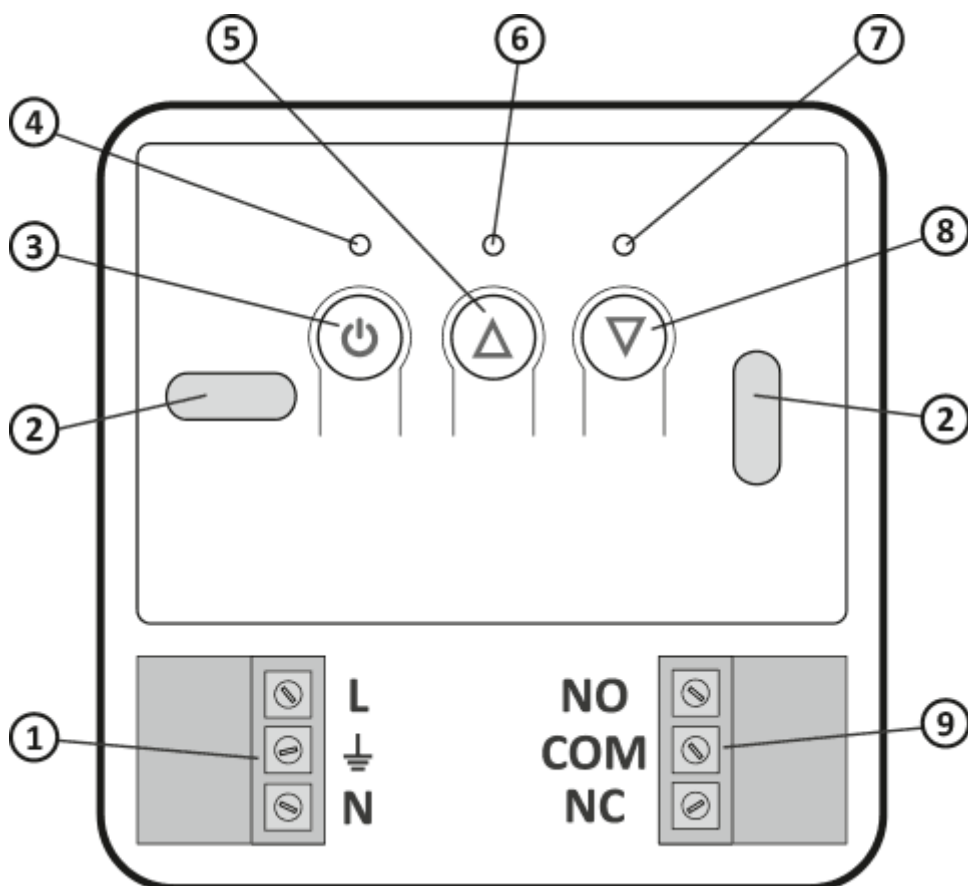



The AURATON RT receiver works with the wireless AURATON 200 RT controller. The receiver is installed near the heating or air conditioning device and may work with the load of **16A/10A**.



1. detachable 230V power supply connection terminals

2. mounting hole
3. power button
4. power supply diode
5. button for unpairing devices
6. diode indicating that the actuator device has been switched on
7. diode indicating that the actuator device has been switched off
8. button for pairing devices with the RT receiver
9. detachable control connection terminals

Legend - description of LED signalling

	The LED light's green - the output device is off (the contacts COM and NC are closed).
	The LED light's red - the output device is on (the contacts COM and NO are closed).
	The LED flashes green - the RT receiver awaits the device to be paired - (chapter: "Pairing the AURATON 200 RT wireless regulator and the RT receiver").
	The LED flashes red - the RT receiver awaits the device to be deregistered - chapter: "Deregistering the regulator from the RT receiver").
	The LED flashes alternating red and green: ALARM - the RT receiver has lost connection with one of the paired devices - (chapter "Special situations") RESET - receiver deregisters all previously paired devices - (chapter "Deregistering all devices paired with the RT receiver")
	Green power supply diode - the RT receiver is switched on.

AURATON 200 RT temperature controller explained

The front of the enclosure has a backlit LCD display and three function buttons.

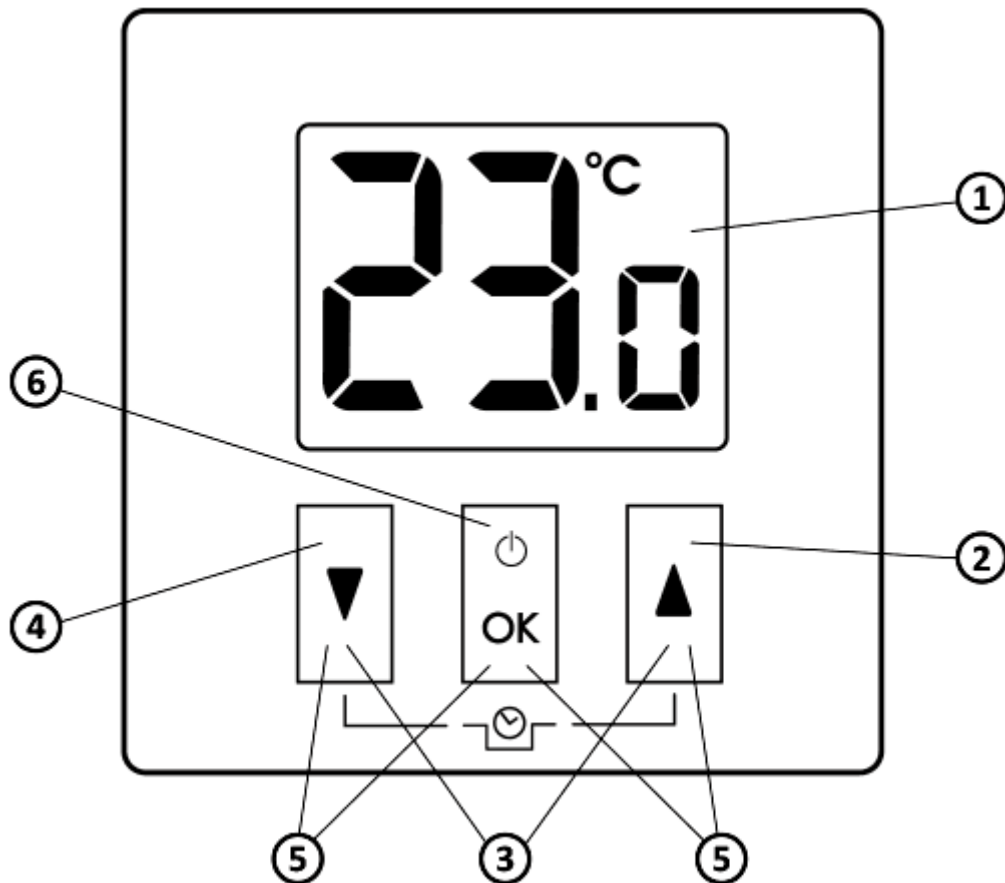

1. LCD display
2. temperature increase key
3. temporary temperature decrease mode keys
4. temperature decrease key
5. Pairing buttons
6. acknowledge or on/off key

- **hold** - controller on/off (🔌)



- **short press** - zacknowledge temperature setting (OK)

Display screen

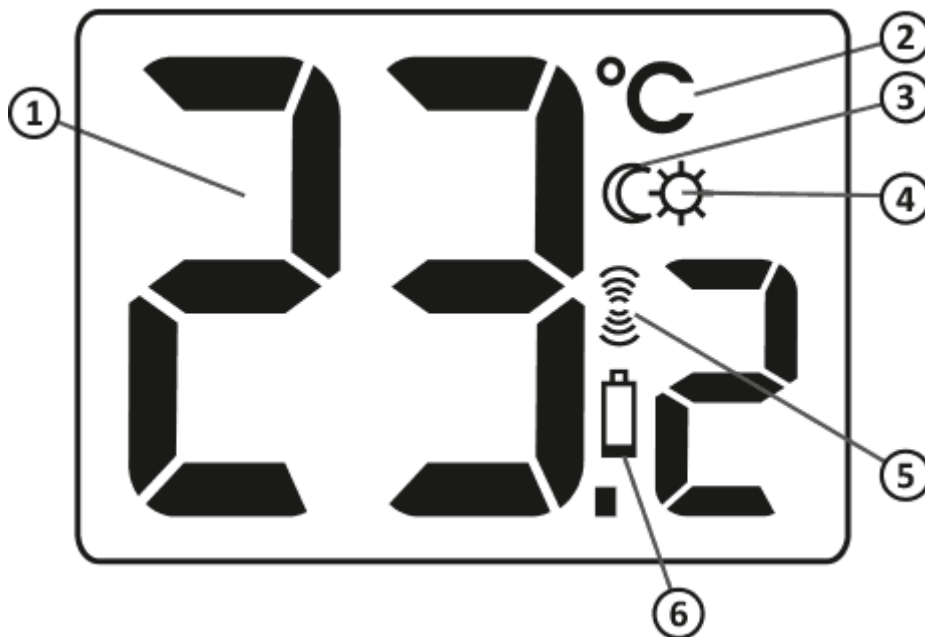

1. **Temperature**

In normal operating mode, the controller displays the temperature of the room it is installed in.

2. **Temperature unit (°C)**

Indicates temperature displayed in centigrade.

3. **Temporary temperature decrease mode indicator (☾)**

Appears when the temporary temperature decrease program is active.

4. **Temporary temperature decrease mode programming indicator (☼)**

Indicates the temporary temperature decrease mode planned by the user.

Displayed when the mode is not executed but the function of the temporary temperature decrease is active (*refer to "Temporary temperature decrease setting" section for more details*).

5. **Transmission symbol (📶)**

Indicates communication with the receiver.

6. **Battery exhausted (🔋)**

Displayed when the battery voltage drops below the allowed limit. Replace the battery as soon as possible.

Selecting proper location for AURATON 200 RT temperature controller

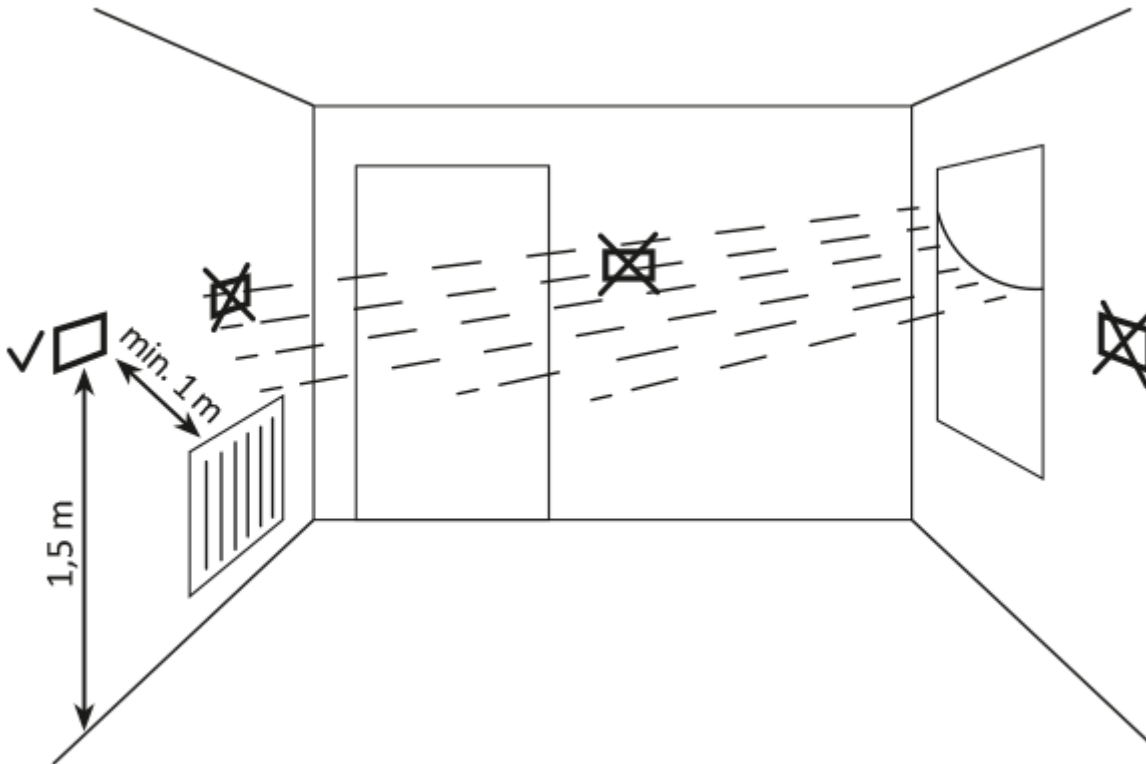

Controller location largely affects its proper operation. When located in a place without air circulation or exposed to direct sunlight, the controller may not control the temperature properly. The controller should be located on an internal wall of a building (partition wall) in a place with free air circulation. Avoid locations near sources of heat (TV set, heater, refrigerator) or places exposed to direct sunlight. Location near doors and the resultant vibration may cause the controller to function improperly.

Battery installation/replacement

Battery sockets are located inside the controller on both sides of the display. To install the batteries, remove the controller enclosure as shown in the figure.

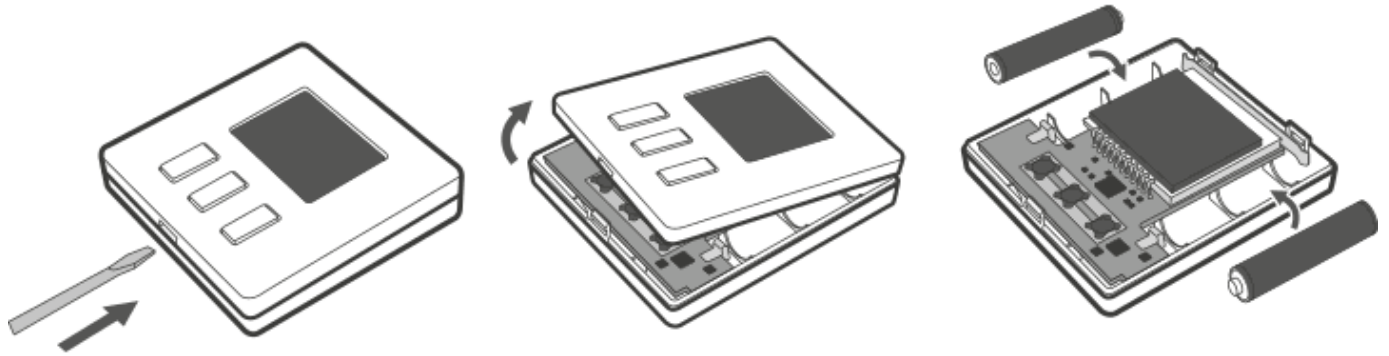

Place two AAA 1.5 V batteries in the battery socket observing the correct polarity.

NOTE:

We recommend using alkaline batteries to supply AURATON controllers. Rechargeable batteries should not be used because their rated voltage is too low.

Fixing the AURATON 200 RT controller to the wall

To fix the **AURATON 200 RT** controller to the wall:

1. Remove the enclosure (*as described on the "Battery installation/replacement" section*).
2. Drill 2 holes diameter 6 mm in the wall (use the back of the controller enclosure to set the right spacing of the holes).
3. Place plastic plugs in the drilled holes.
4. Screw the back of the controller enclosure to the wall with the two screws provided.
5. Install the batteries and replace the controller enclosure.

NOTE:

No expansion bolts are needed for wooden walls. Just drill holes diameter 2.7 mm (instead of 6 mm) and screw the screws directly into the wood.

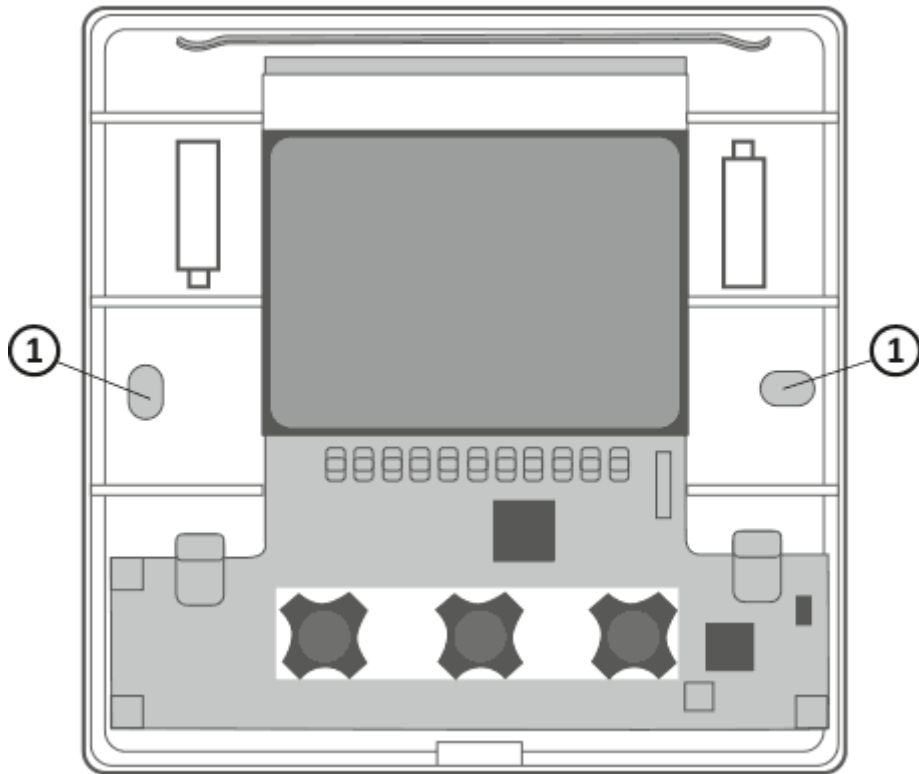

1. hole for a mounting screw

Alternative fixing methods

The controller can be mounted to a smooth surface with e.g. two-sided adhesive tape. The controller can also be placed in any location on an even surface on a support at the back of the enclosure.

Installation of the AURATON RT receiver



CAUTION!

The cables delivered



in a set together with the controller are suitable for maximum loads equal to 2.5 A.

If devices with higher power are connected, the cables should be replaced with ones of appropriate cross-sections.

NOTE:

When installing an AURATON RT receiver, make sure that the power supply is switched off. The receiver should be installed by a professional.

NOTE:

In the permanent system of the building there must be a switch and an overcurrent protection.

NOTE:

In order to facilitate installation, the terminals are fitted with extendable clamps. Before cable connections are made, they can be disconnected from the controllers. The cables may be routed from the bottom of the receiver by breaking out holes in the mounting cover or from the back of the receiver if the cables are extended from the wall. In order to connect the cables from the back, the cover must be broken out.

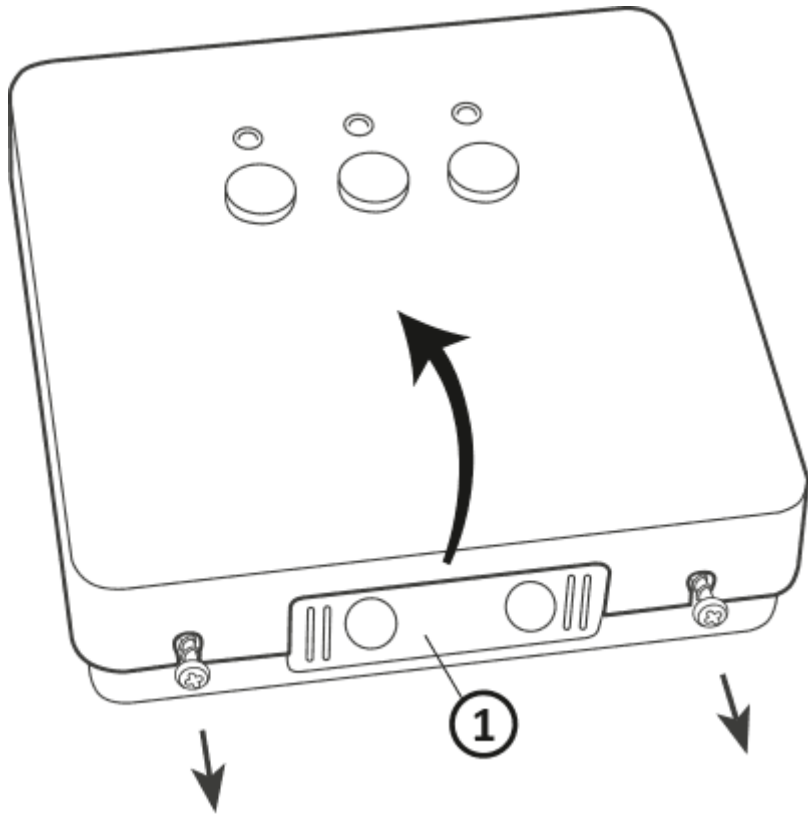

1. mounting pluga

Take off the cover of the front part of the AURATON 200 RT receiver by unscrewing the screws half way out.

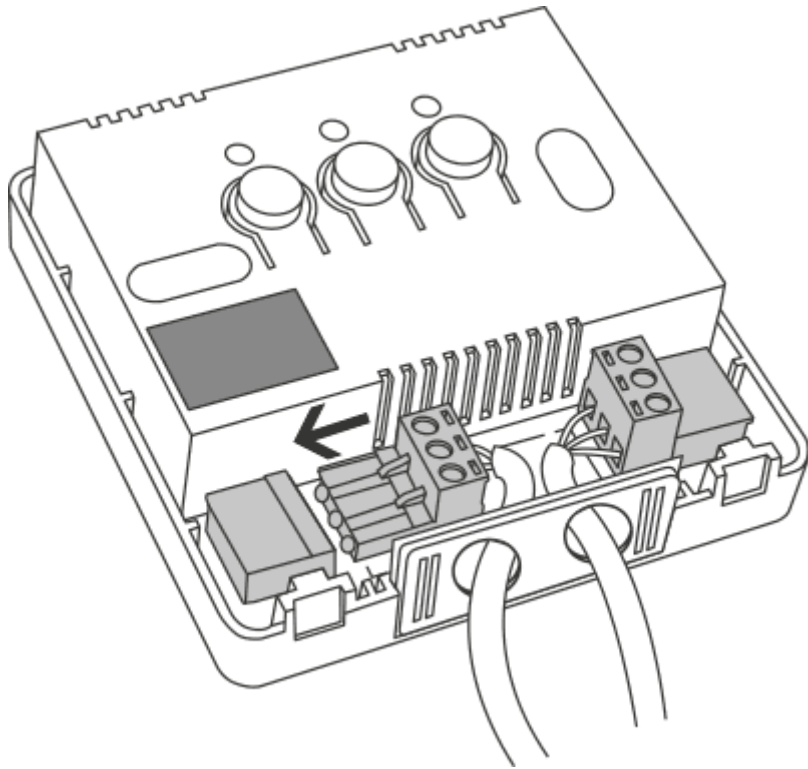

Connect the heating device to the terminals of the control connection of the AURATON 200 RT receiver. Follow the service instruction of the heating device. The COM (common) and NO (normally opened) terminals are used the most often.

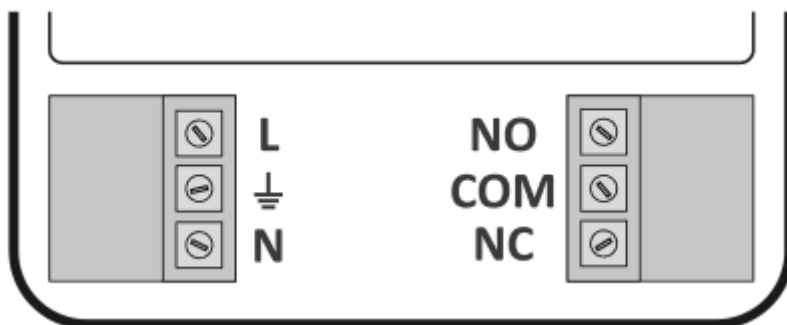

Connect the power supply cables to the terminals of the power supply connection of the AURATON RT

receiver, in observance of safety rules.

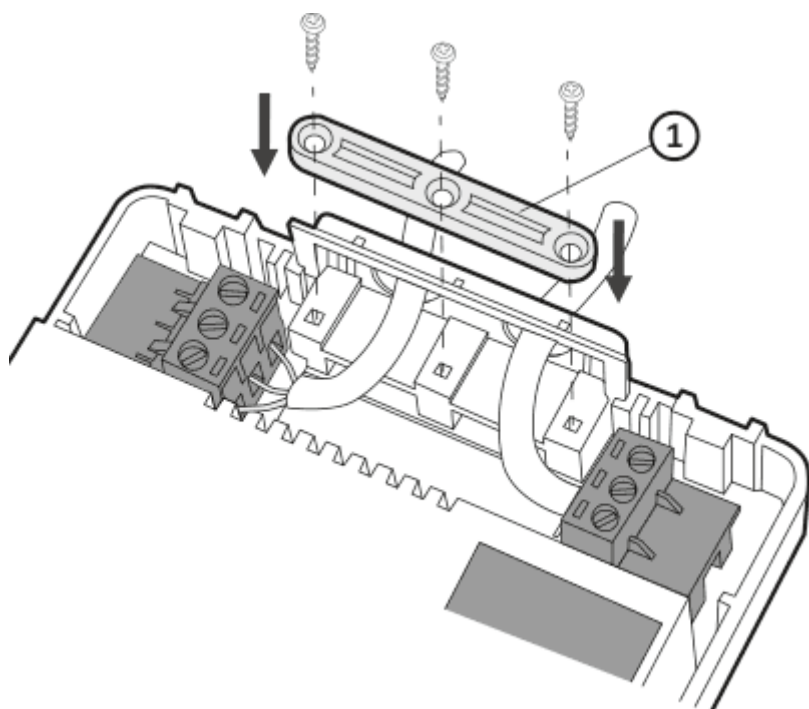

1. cable tie clamp

After the cables are connected, they must be fixed with the “cable fastening holder” and the covers must be screwed back to the AURATON 200 RT receiver.

Fastening the AURATON 200 RT receiver to a wall

In order to fasten the AURATON 200 RT receiver on a wall:

1. Take off the covers from the front part of the controller (see chapter “Installation of the AURATON RT receiver”).
2. Mark the location of the holes for the fastening screws on the wall.
3. In the marked locations, drill holes with diameters appropriate for the diameters of the enclosed wall plugs (5 mm).
4. Put the wall plugs in the drilled holes.
5. Fasten the AURATON RT receiver to the wall using screws so that the receiver is well fastened.

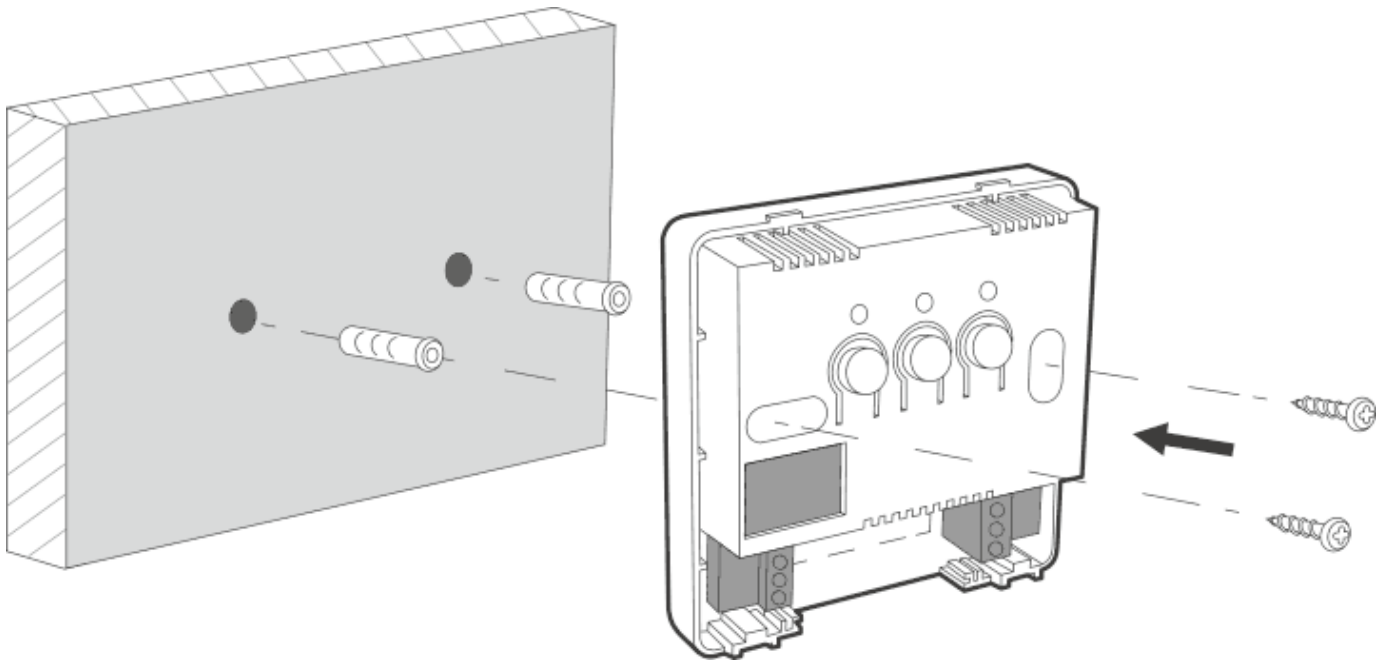

NOTE:

If the wall is wooden, there is no need to use wall plugs. In such a case, drill two holes 2.7 mm in diameter instead of 5 mm, and screw the screws directly into the wood.

NOTE:

The RT receiver cannot be placed in metal containers (e.g. an assembly box, a metal enclosure of a heater) in order to not to interfere with its operation.

Pairing of the wireless AURATON 200 RT controller with the AURATON RT receiver

After the receiver is connected to the network, the receiver must be switched on by quickly pressing the power button (🔌). If the device is switched on, the green power supply diode becomes illuminated and a single sound signal is emitted. In order to switch off the receiver, e.g. outside of the heating season, press the power button and hold it for 3 seconds until a double sound signal is audible and the green power supply diode is switched off and, consequently, the heating device is switched off.

NOTE:

If the wireless controller AURATON 200 RT is sold together with the AURATON RT receiver, the two devices are factory-paired. Devices purchased separately must be paired.







1. Pairing of the AURATON 200 RT controller with the AURATON RT receiver is initiated by pressing the right pairing button (📶) a single sound signal is emitted – on the AURATON RT receiver and by holding it pressed for at least 3 s until the LED diode starts blinking with green light (double sound signal) – then the button must be released.
The AURATON RT receiver waits for pairing for 120 seconds. After this period, it automatically returns to normal operation.
2. On the AURATON 200 RT regulator, press and hold the buttons ⏴🔌 or ⏵🔌 for 6 seconds until the transmission symbol (📶) appears on the display. Release the button – the regulator transmits the pairing signal for 5 seconds.
3. Successful end of pairing is indicated by the LED diode on the AURATON RT receiver no longer blinking green, emission of a single sound signal, and the receiver switching to normal operation.

*In the event of a pairing error, steps 1 and 2 must be repeated. If more errors occur, all devices must be unpaired by **RESETTING** the AURATON RT receiver (see „RESET – Unpairing all devices paired with the AURATON RT receiver“) and then an attempt must be made to pair the devices again.*

NOTE:



Only 1 temperature controller may be paired with one receiver.

Unpairing of the controller and the RT receiver

1. Unpairing of the AURATON 200 RT controller from the AURATON RT receiver is initiated by pressing the left unpairing button () on the receiver and holding it for at least 3 seconds until the LED diode starts blinking red – then the button must be released. The sound signal works in the same way as during pairing, i.e. when a button is pressed, a short sound is emitted and another short sound signal after 3 seconds.
The AURATON RT receiver waits for unpairing of the device for 120 seconds. After this period, it automatically returns to normal operation.
2. On the AURATON 200 RT regulator, press and hold the buttons   or   for 6 seconds until the transmission symbol () appears on the display. Release the button – the regulator transmits the pairing signal for 5 seconds.
3. A properly completed deregistering process is signalled by the LED on the AURATON RT receiver no longer flashing red and the receiver reverting back to normal operation.

In the event of an error during the deregistering process, repeat steps 1 and 2. Should more errors occur, deregister all paired devices (see “RESET – Deregistering all devices paired with the RT receiver”) and attempt to pair the device again.

RESET - Deregistering all devices paired with the RT receiver

In order to deregister all devices paired with the RT receiver, simultaneously press both the pairing and the deregistering button ( ) and hold them for at least 5 seconds until the LED flashes alternating red and green. Then release both buttons.

A properly completed process of deregistering all devices is signalled after approx. 2 seconds by the LED colour changing to green and then switching it off for a short period of time.

NOTE:

If after executing the RESET function the RT receiver is disconnected from power supply and then connected again, the receiver will automatically enter “pairing” mode for 120 seconds. A newly purchased RT receiver without any factory-paired devices (i.e. not the one bundled with the regulator) will behave the same way.

Signalling operation and reception of data packet

Each radio transmission received by the AURATON RT receiver from the paired device is signalled by a temporary change of LED colour to orange. Switching on the relay is signalled by the LED lit red, whereas switching it off is signalled by the LED lit green.

NOTE:

When any button is pressed, a short sound signal is emitted.

Starting the AURATON 200 RT controller for the first time

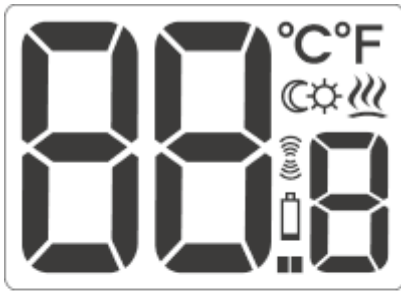

After correct installation on batteries, the LCD will display, for a second, all segments (display test) followed by the firmware version number.

After a while, the current temperature in the room will be displayed. The controller is ready to use.





Temperature setting

NOTE:

When pressing any function key for the first time, the backlight is turned on and then the key function is activated.



To set the desired temperature in normal operating mode:

1. Press the  or  key. The segment displaying temperature will switch to edit mode and start blinking.
2. With the  and  keys, set the desired temperature with the accuracy of up to 0.2°C
3. Press the  key to acknowledge selection.

FrostGuard function

AURATON 200 RT controller features the special FrostGuard function to protect the room from possible freezing.



The function is activated when the controller is **switched off**.

With the controller switched off, when the room temperature drops to 2°C, the Fr (**Fr**) symbols will appear and signal will be sent to the receiver to start heating. When the temperature raises to 2.2°C, the display will turn off again and signal will be sent to the receiver to turn the heating off.

Setting the temporary temperature decrease mode



If, for some reasons, you would like to decrease temperature in the room, everyday and at the same time, by 3°C, temporary reduction for 6 hours is possible. To do so:

1. Press and hold for 3 seconds both   keys. The moon symbol will be displayed ().
2. The controller is switched to the temporary temperature decrease mode and **everyday at the same time** will decrease the set temperature in a normal mode by 3°C for 6 hours.



NOTE:

After 6 hours, the controller will return to the main temperature setting. Instead of the moon symbol (☾), the sun (☀) symbol will be displayed.

NOTE:

The temporary temperature decrease mode always starts when the function is turned on. This means that the possible temporary temperature decrease has to be set at the time you want it to take place.

Switching off the temporary temperature decrease

Press and hold the   keys again to switch off the temporary temperature decrease mode.



The moon (☾) or sun (☀) symbol will disappear and only the room temperature will be displayed. The controller returns to the normal operating mode.

Changing hysteresis

Hysteresis prevents the device from switching on too often due to insignificant temperature fluctuation.

*E.g. with **HI 2** hysteresis and temperature setting of 20°C, the boiler switches on at 19.8°C and switches off at 20.2°C. With **HI 4** hysteresis and temperature setting of 20°C, the boiler switches on at 19.6°C and switches off at 20.4°C.*



To change hysteresis, press ,  and  simultaneously and hold for 3 seconds. When hysteresis change mode is active, message **HI** is displayed.

Use  and  to change hysteresis settings..

HI 2 - $\pm 0,2^{\circ}\text{C}$ (*factory setting*)

HI 4 - $\pm 0,4^{\circ}\text{C}$

HI P - PWM mode (*see chapter "PWM mode"*).

Press  to confirm your selection. The controller resumes normal operation.

Pulse-Width Modulation mode

(PWM)

When changing hysteresis settings, you can enable PWM mode. In PWM mode, the controller switches on the heating device in cycles to minimize temperature fluctuations. The controller monitors the temperature rise and drop time.

With these values determined, the controller switches the heating device on and off in cycles that enable maintaining temperature as close to the setpoint as possible.

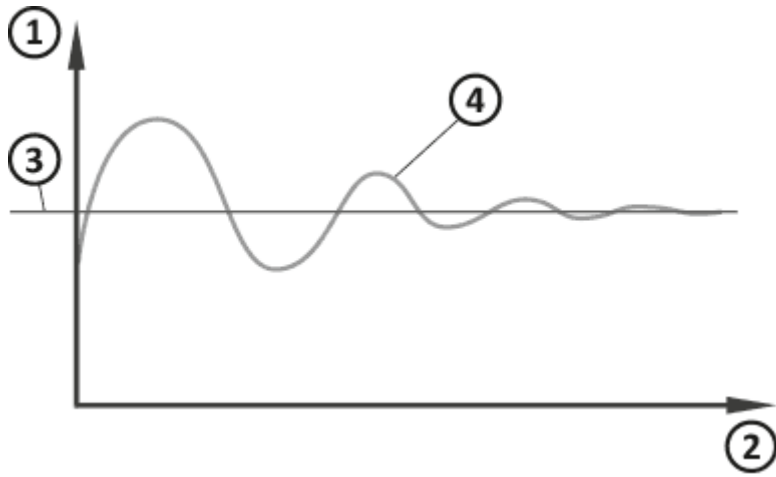

1. Temperature
2. Time
3. Preset temperature
4. Room temperature

CAUTION:

In PWM mode, the controller can switch on the heating device even though the temperature in the room is higher than preset temperature. This is because the PWM algorithm tries to maintain the preset temperature and stays ahead of the heating system behaviour.

Cooperation of the RT receiver with a heating device

Basic configuration of devices

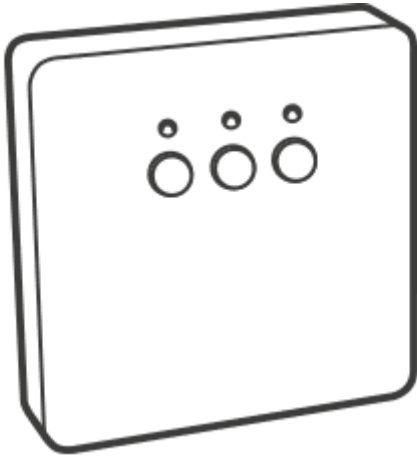

AURATON RT
Receiver connected
to the heating device

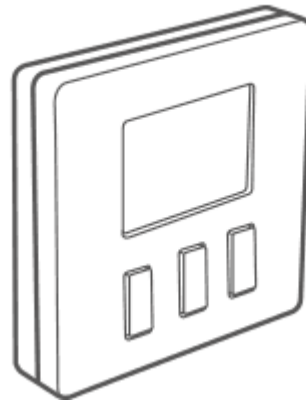

AURATON 200 RT
Wireless temperature regulator

Additional system devices

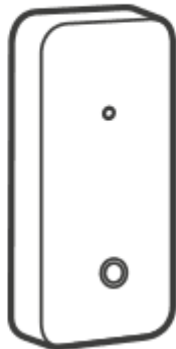

AURATON T-2
Wireless thermometer
(sold separately)



AURATON H-1
Window handle
(sold separately)

AURATON RT simplified connection diagram with heating device

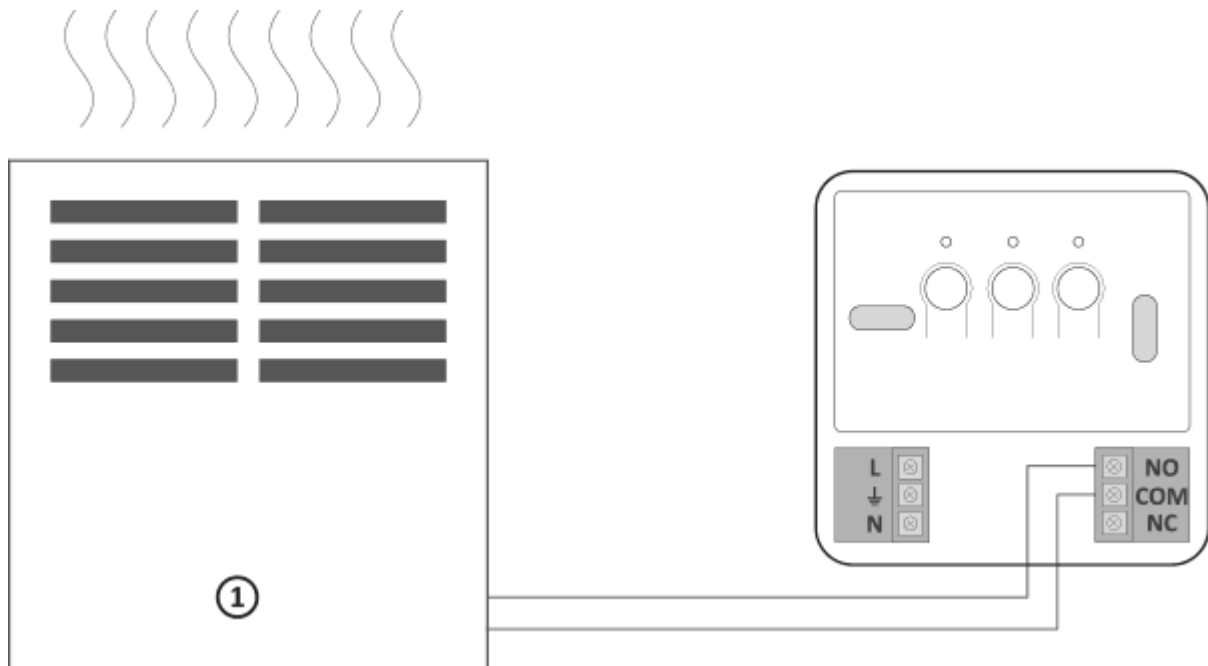

1 - heating device

Cooperation of the AURATON RT receiver with the AURATON 200 RT regulator and/or the AURATON T-2 thermometer

The operation of temperature regulation in the receiver is based on the binary algorithm (on/off) using one or two sensor elements.

- The AURATON 200 RT regulator allows for setting and/or monitoring the temperature.
- The AURATON T-2 thermometer provides information about the current temperature only, without the capability of changing it manually.

1. **The manual setpoint** - pairing the AURATON 200 RT regulator with the RT receiver allows for setting the temperature manually and controlling it in the location of the fastening of the 200 RT regulator.
2. **The remote setpoint** - if the T-2 thermometer is additionally paired with the RT receiver, the AURATON 200 RT regulator retains the capability of temperature setting, however its control is performed with the paired T-2 thermometer only. This feature allows for regulating the temperature in a room other than the one where the AURATON

200 RT regulator is placed.

An example: you want the temperature in the “children’s room” to be always at 22 °C, however you do not want children to be able to change it – in that room, you install the T-2 thermometer, and the AURATON 200 RT regulator in e.g. the kitchen. This way the temperature in the “children’s room” will always be at 22 °C regardless of temperature fluctuations in the kitchen.

3. **The factory setpoint (20°C)** – if the T-2 thermometer is the only device paired with the RT receiver, it is not possible to set the temperature manually, and the RT receiver maintains the factory temperature setpoint of 20 °C.

NOTE:

- The sequence of pairing the AURATON 200 RT regulator and the T-2 thermometer is very important. If you want to maintain the remote setpoint, you must first pair the AURATON 200 RT with the RT receiver, and then the T-2 thermometer. Reversing the pairing sequence will cause automatic deregistering of the previously paired T-2 thermometer and entering the mode of operation described in item A.
- The RT receiver can operate with one AURATON 200 RT regulator and/or one T-2 thermometer only. Pairing a new regulator causes deregistering the previously paired regulator and the T-2 thermometer. Pairing a new T-2 thermometer causes deregistering the previously paired T-2 thermometer only.
- The 200 RT regulator and/or the T-2 thermometer can operate with an unlimited number of receivers, e.g. one regulator can simultaneously control two independent heating devices.
- In the case of the AURATON 200 RT regulator with the T-2 thermometer, the operation indicator on the 200 RT controller’s display does not reflect the operation of the heating device.

Cooperation with the AURATON 200 RT regulator and/or the AURATON T-2 thermometer as well as the AURATON H-1 handles

By default, the AURATON RT receiver does not have any AURATON H-1 handle or AURATON W-1 window position sensor paired, therefore the relay is controlled by the paired AURATON 200 RT regulator and/or the AURATON T-2 thermometer. When at least one H-1 handle is paired with the RT receiver, the relay is controlled in the following manner:

1. **The window is closed or trickle-ventilated (micro-ventilation).**

When the H-1 window handle is paired with the receiver, and all windows are closed or trickle-ventilated, the relay still maintains the setpoint from the paired AURATON 200 RT regulator and/or the T-2 thermometer.

2. **The window is pivoted.**

If at least one window is pivoted, the temperature set in the AURATON 200 RT regulator is lowered in AURATON RT receiver down to 3 °C. This state will be maintained until closing. This state will last until all windows are closed or trickle-ventilated.

3. **The window is opened.**

When you open a window equipped with the H-1 handle paired for longer than 30 seconds, the relay in the AURATON RT receiver is switched off, as is the connected heating device. If all the assigned windows are again in a state other than “opened”, the RT receiver returns to normal cooperation with the AURATON 200 RT regulator and/or the T-2 thermometer no earlier than 90 seconds after switching off the relay. The purpose of this delay is to prevent too rapid transitions of the connected heating devices between the ON and OFF states. However, if the temperature in the room drops below 7 °C, the relay inside the receiver is switched on regardless of the positions of windows in order to prevent the room from freezing.

4. **The signal is lost.**

When the RT receiver has lost the signal from the H-1 handle paired (3 consecutive transmissions are lost), it changes the status of this window to “closed”. When the transmission is restored, the H-1 handle is again properly read off by the RT receiver.

Special situations

- When 3 consecutive transmissions (after 15 minutes) from the AURATON 200 RT regulator and/or the T-2 thermometer are lost, an error is signalled on the RT receiver (LED flashing continuously red and green). The RT receiver starts executing the ON - OFF cycle memorised during the last 24 hours of operation until the problem is removed.
- When both signals return (from the AURATON 200 RT regulator and the T-2 thermometer), the error is cancelled and the receiver enters its normal mode of operation.
- When only the T-2 thermometer signal returns, the receiver uses the last memorised setpoint value and maintains it while signalling the error.
- When the H-1 handles, the T-2 thermometer and the AURATON 200 RT regulator (the temperature is measured with the T-2 thermometer) are paired with the receiver, then maintaining the work cycle from the last 24 hours occurs only after losing the signal from the T-2 thermometer. When only the signal from the AURATON 200 RT is missing, the RT receiver automatically maintains the last memorised setpoint from the AURATON 200 RT regulator and also signals an error.
- When you have only the H-1 handles and the T-2 thermometer paired with the RT receiver without the AURATON 200 RT regulator, the RT receiver maintains a constant, factory-defined temperature of 20 °C. If you pivot any window equipped with the H-1 handle paired with the receiver, a temperature of 17 °C is maintained. If you open any

window equipped with the H-1 handle paired with the RT receiver, the receiver switches off the heating device, but will switch it back on when the temperature falls below 7 °C.

Unique features of AURATON 200 RT

- Switching the relay is synchronised with the wave of the 230 V mains voltage in order to ensure that closing and opening contacts of the relay occurs around the zero-crossing point. This prevents the occurrence of an electric arc, significantly extending the relay service time.
- The AURATON RT receiver is equipped with a unique algorithm for analysing the ON-OFF cycles. The entire heating cycle from the last 24 hours is recorded in the memory of the RT receiver. In the event of losing communication with the AURATON 200 RT regulator and/or the T-2 thermometer, the RT receiver automatically executes the ON-OFF cycle memorised during the last 24 hours. This provides time for restoring transmission (removing interferences) or fixing the 200 RT regulator and/or the T-2 thermometer without a significant deterioration of thermal comfort conditions in the controlled spaces.
- Cooperation with optional devices (the AURATON T-2 thermometer, the AURATON H-1 window handle).

Additional information and notes

- The AURATON 200 RT regulator and/or the T-2 thermometer must be installed at least 1 metre from the RT receiver (too strong a signal from the transmitters can cause interference).
- At least 30 seconds must elapse between switching the relay off and on.
- Data transmission from the AURATON 200 RT regulator to the receiver occurs upon each change of 0.2 °C of the surrounding temperature. When the temperature is stable, the regulator sends heart-beat data every 5 minutes (which is signalled with the LED blinking orange on the RT receiver).
- In the event of a power outage, the RT receiver will switch off. When power is restored, the heating device is switched on automatically, and the RT receiver awaits a signal from the paired transmitters (this signal should be received within 5 minutes of restoring power). After receiving the signal, the RT receiver enters the normal mode of operation.
- The RT receiver cannot be placed in metal containers (e.g. an assembly box, a metal enclosure of a heater) in order to not to interfere with its operation.
- The controller can be switched on or off at any time by holding the  key pressed for a while.

- Pressing any function key for the first time always starts the backlight first, and then the key function is performed.
- While programming any function, if no key is pressed for 10 seconds, this will be interpreted as pressing the  key.

Cleaning and maintenance

- Clean the outside of the device with a dry cloth. Do not use from solvents (such as benzene, thinner or alcohol).
- Do not touch the device with wet hands. It may cause electric shock or serious damage to the device.
- Do not expose the device to excessive smoke or dust.
- Do not touch the screen with a sharp object.
- Avoid contact of the device with liquids or moisture.

The AURATON RT receiver connection schematics

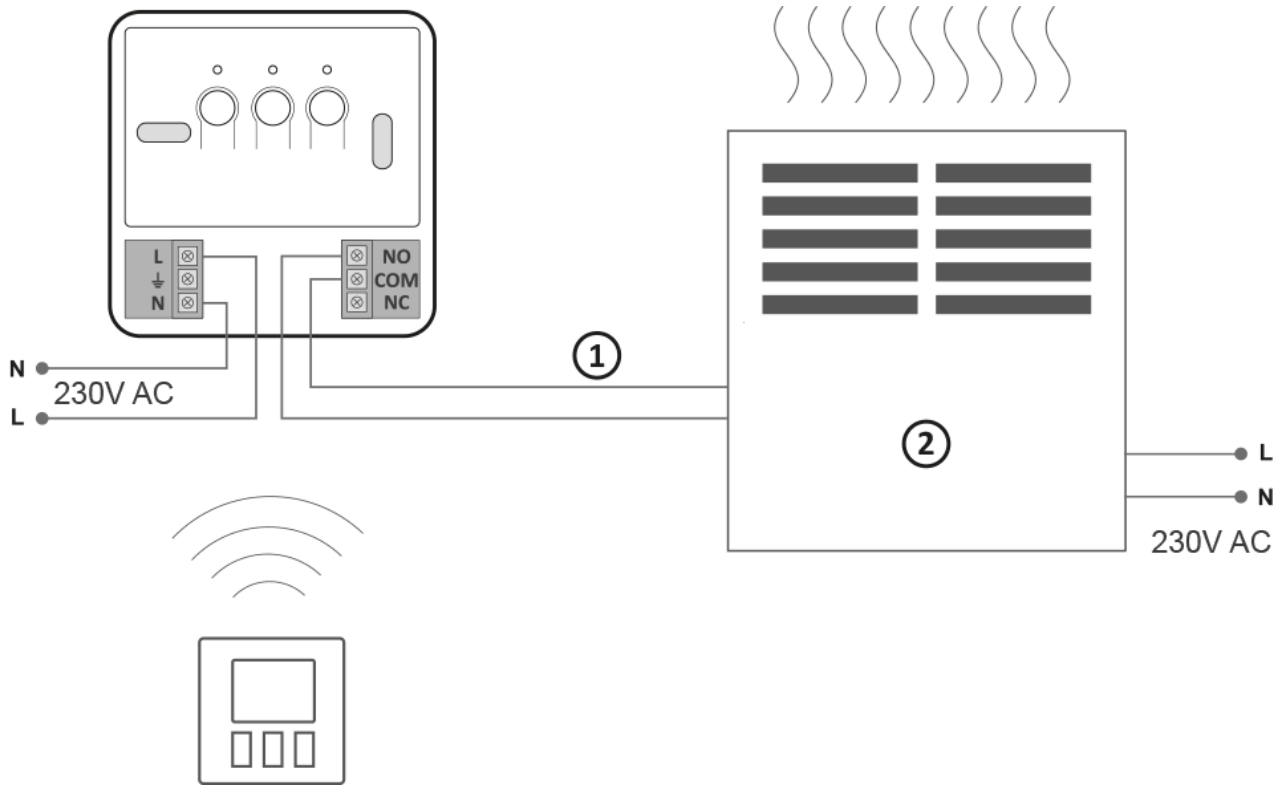

- 1 - control
- 2 - heating device, e.g. a gas furnace

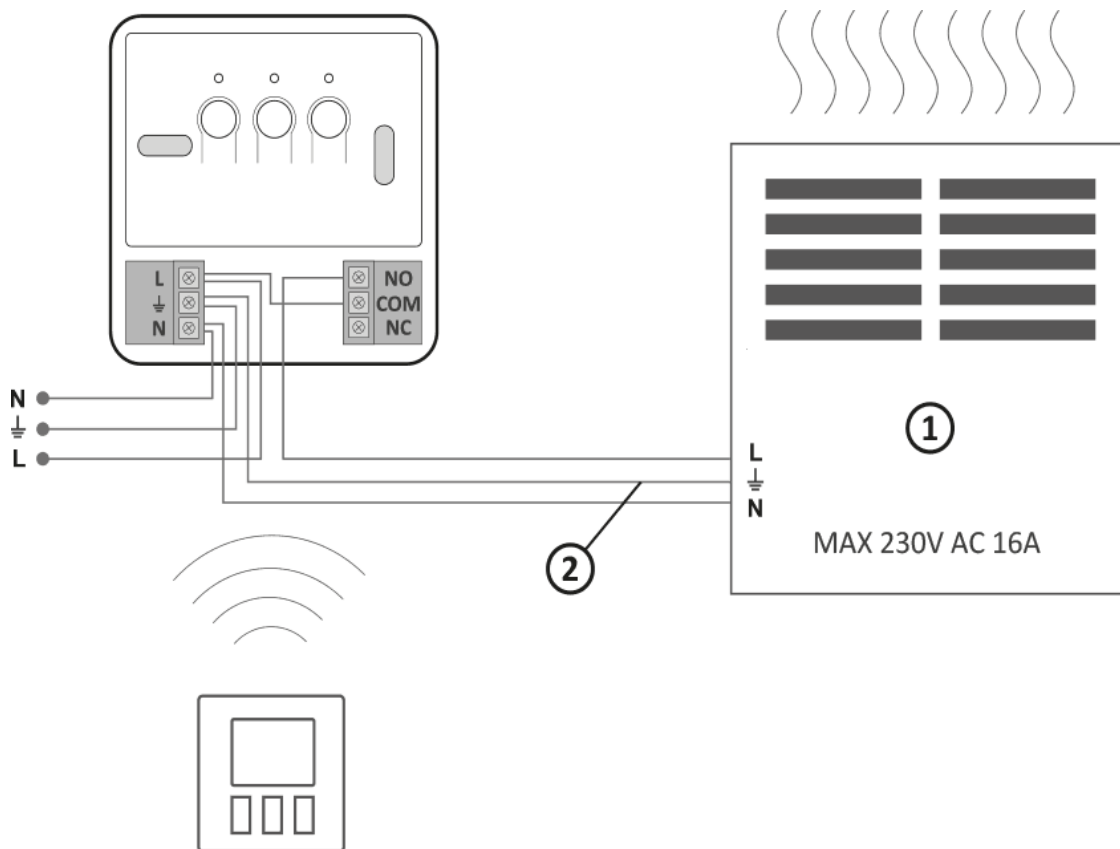

1 - electric heating device

2 - protective (⏏)

Technical specifications

Working temperature range:	0 - 45°C
Temperature measurement range:	0 - 35°C
Temperature control range:	5 - 30°C
Span:	+/-0,2°C; +/-0,4°C PWM
Temperature setting accuracy:	0,2°C
Temperature reading accuracy:	0,2°C
Default temperature setting:	20°C
Additional function:	FrostGuard
Operating cycle:	Daily
Working mode control:	LED (the RT receiver) / LCD (the regulator)
Security level:	IP20

AURATON 200 RT power supply: 2 x AAA 1.5V alkaline batteries

RT power supply: 230V AC, 50Hz

RT radio frequency: 868 MHz

RT Operation range: in a typical building, with standard construction of walls – approx. 30 m
an open space – up to 300 m

Disposing of the devices



The devices are marked with the crossed waste bin symbol. According to European Directive no. 2012/19/EU and the Act concerning used up electric and electronic equipment, such a marking indicates that this equipment may not be placed with other household generated waste..

The user is responsible for delivering the devices to a reception point for used-up electric and electronic equipment.

Download

- [User manual](#)
 - [Declaration of conformity](#)
-