



AURATON Cetus

User manual ver. 20211103

The document collects information concerning safety, assembly and use of the device AURATON Cetus.

Daily hard-wired temperature thermostat (single-sensor)

AURATON Cetus is a daily, hard-wired thermostat designed to work with a gas or electric heating device.



FrostGuard function

Protects against freezing of the room.



Possibility of temporarily lowering the programmed temperature

For a maximum of 12 hours.



Holiday mode

Up to eight days independent of the programmed temperature.

LCD

Backlit LCD display

The backlit display allows you to supervise the operation of the device even in poorly lit rooms.

Description of AURATON Cetus

daily hard-wired temperature thermostat

On the front part of the thermostat housing there is a backlit LCD display, four function buttons and a temperature setting knob with the  button.

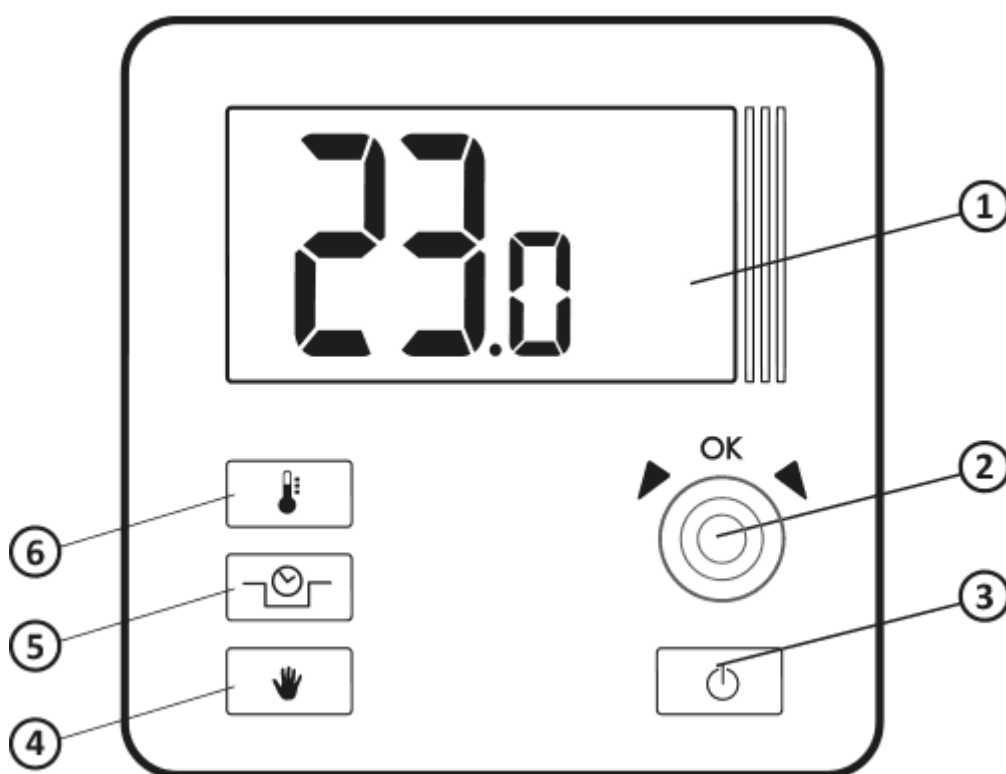

1. LCD display
2. Setting knob with integrated  button
3. Thermostat on/off button
4. Manual mode button
5. Button for "temporary temperature lowering" mode
6. Temperature setting button

Display

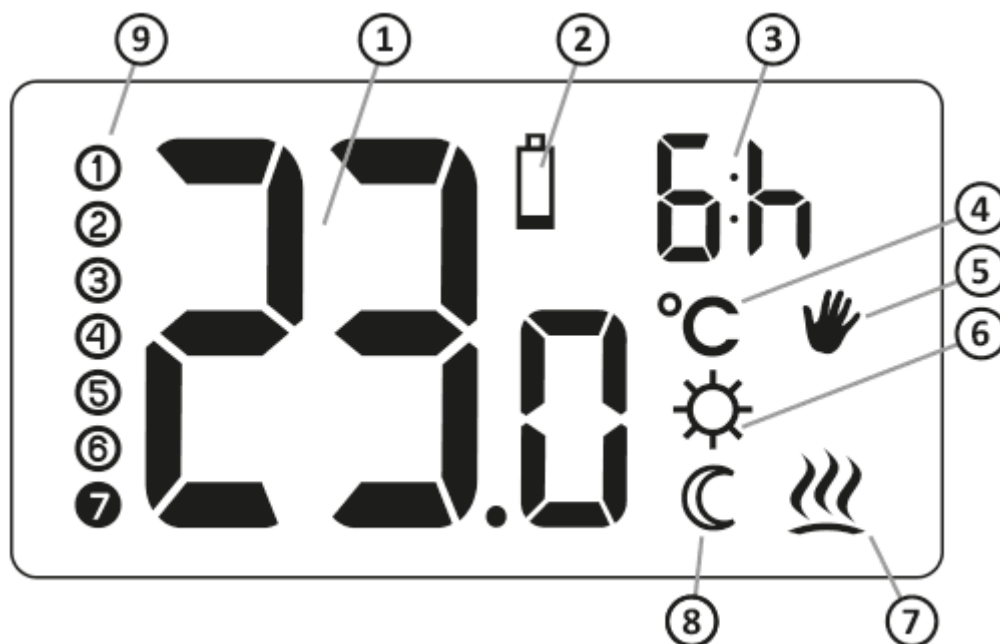

1. **Temperature** – In normal operation mode, AURATON Cetus displays the temperature of the room in which it is installed.
2. **Battery depletion** (🔋)
Indicator visible when the minimum acceptable battery voltage is exceeded. Replace the batteries as soon as possible.
NOTE: In order to maintain the programmed parameters, the battery replacement operation time should not exceed 30 seconds.
3. **Indication of the duration of the “temporary temperature lowering”**
It indicates how long the “Temporary temperature lowering” mode will remain active.
4. **Temperature unit**
It indicates that the temperature is displayed in degrees Celsius (°C).
5. **Manual mode indicator** (👋)
It indicates switching to manual (holiday) temperature setting mode.
6. **Programming indicator for temporary temperature lowering mode** (⚙️)
It indicates a user-scheduled “temporary temperature lowering” mode. It appears when the mode is not currently running, but the “temporary temperature lowering” function is active. (for more information, see the chapter “Setting the temporary temperature lowering mode”).
7. **Indicator of AURATON Cetus switch-on** (🔥)
Pictogram indicating the working status of the device. Visible when the controlled device is switched on.
8. **Temporary temperature lowering mode indicator** (🕒)
It appears while the temporary temperature lowering program is running
9. **Number of days in “holiday” mode** (🕒-🔥)
It indicates the number of days for which vacation mode has been scheduled.

Choosing the right location for AURATON Cetus

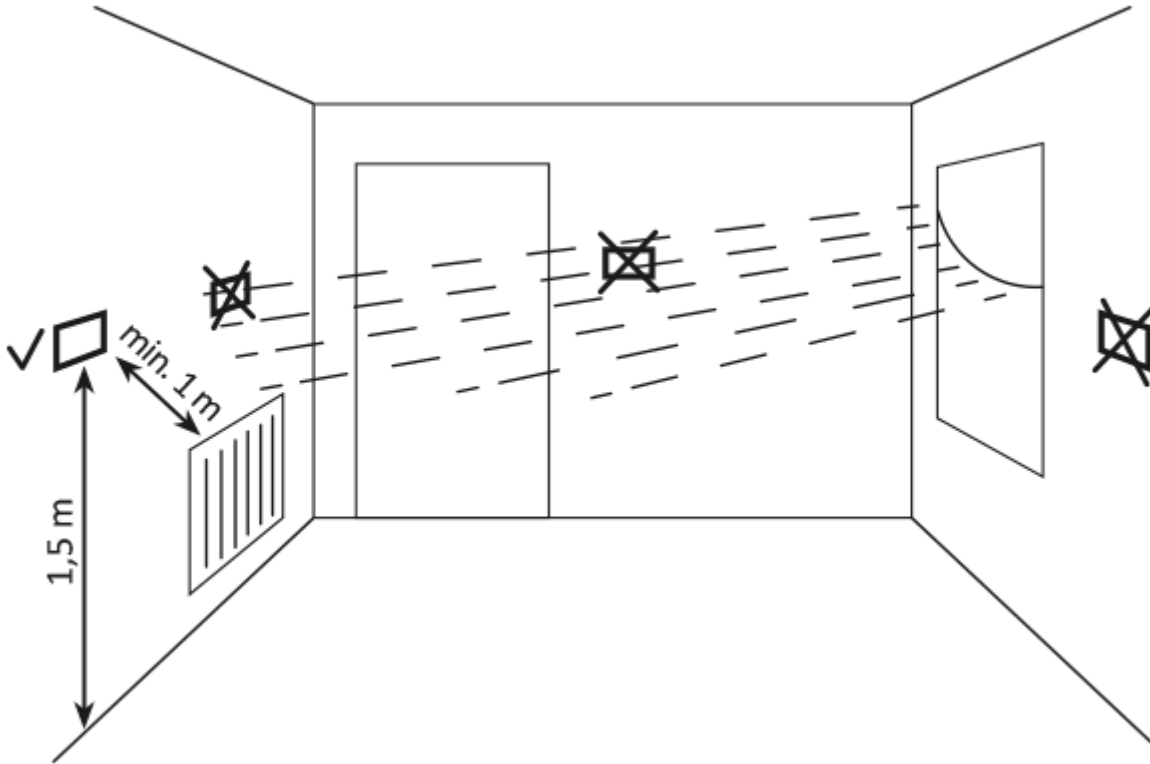

The correct operation of AURATON Cetus is largely influenced by its location. The location in a place without air circulation or in direct sunlight may cause improper temperature control. AURATON Cetus should be installed on an internal wall of a building (partition wall) in an environment of free air circulation. Avoid proximity to heat emitting appliances (TV, heater, refrigerator) or locations directly exposed to sunlight. Problems in proper operation may be caused by the proximity of the door, exposing AURATON Cetus to possible vibrations.

Connecting the wires to AURATON Cetus

To connect the wires, remove the housing as shown below:

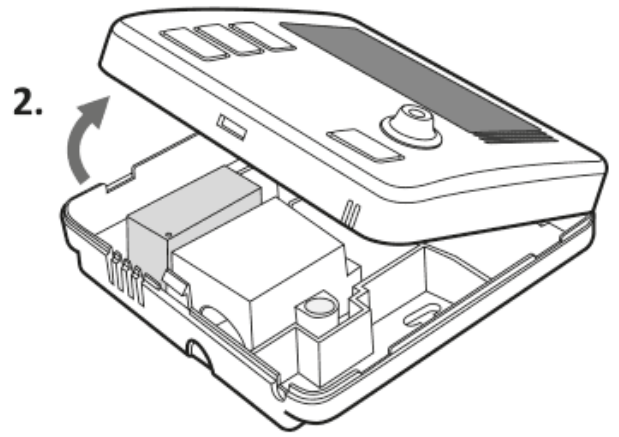
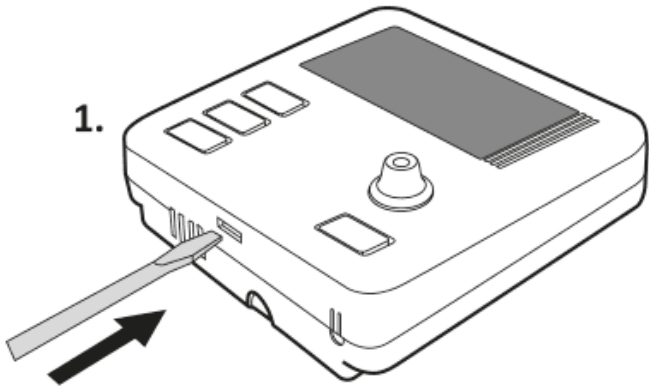

Wire terminals are located on the rear panel of AURATON Cetus, **under a plastic cover**.

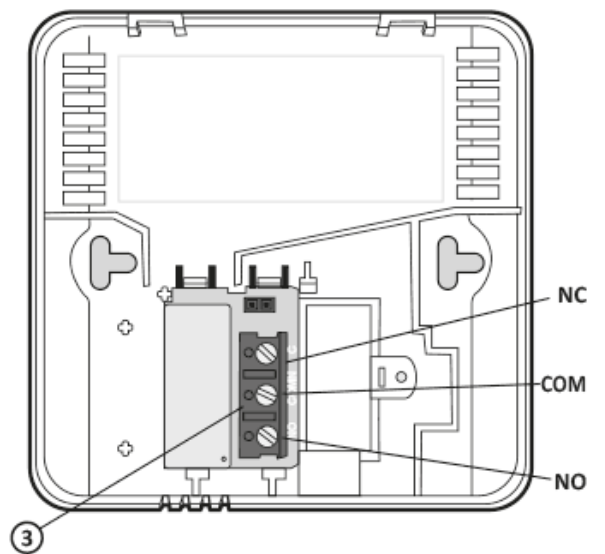
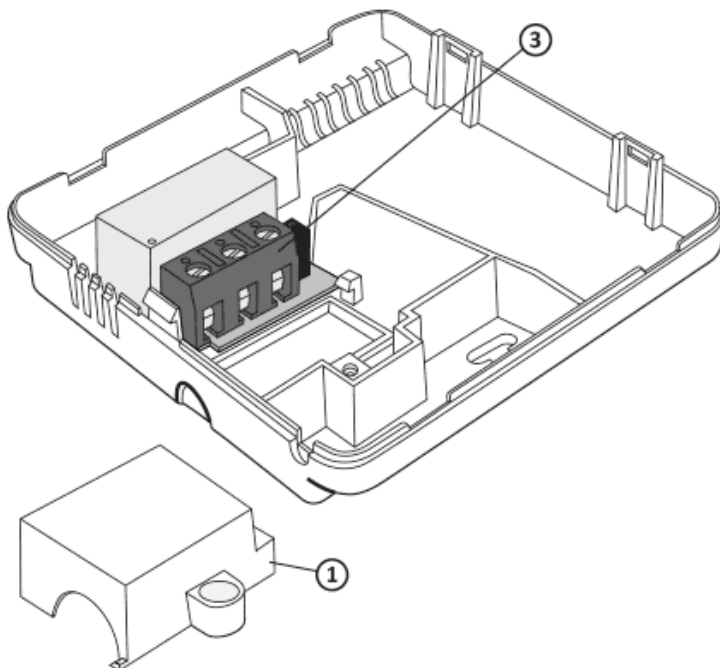
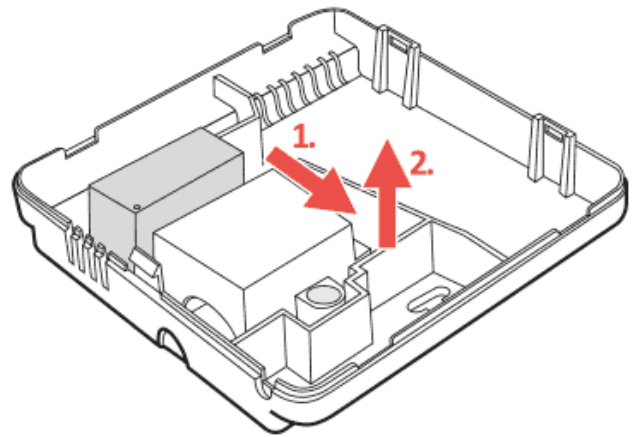
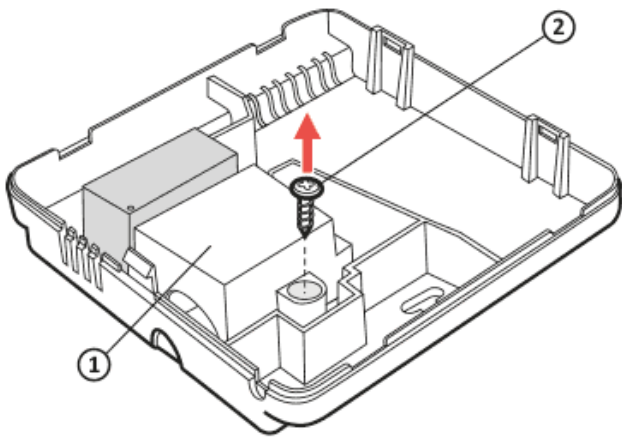

1. cover
2. screw
3. wire terminals

It is a typical single-pole double-throw relay. In most cases, the NC terminal is not used.

NOTE:

After connecting the wires, reinstall the plastic cover.

Battery replacement

The battery socket is located inside AURATON Cetus on the front part of the housing. To install the batteries, remove the thermostat housing as shown in section “Connecting the wires to AURATON Cetus”.

NOTE:

To power AURATON thermostats, we recommend alkaline batteries. Do not use “rechargeable batteries” because the voltage rating is too low.

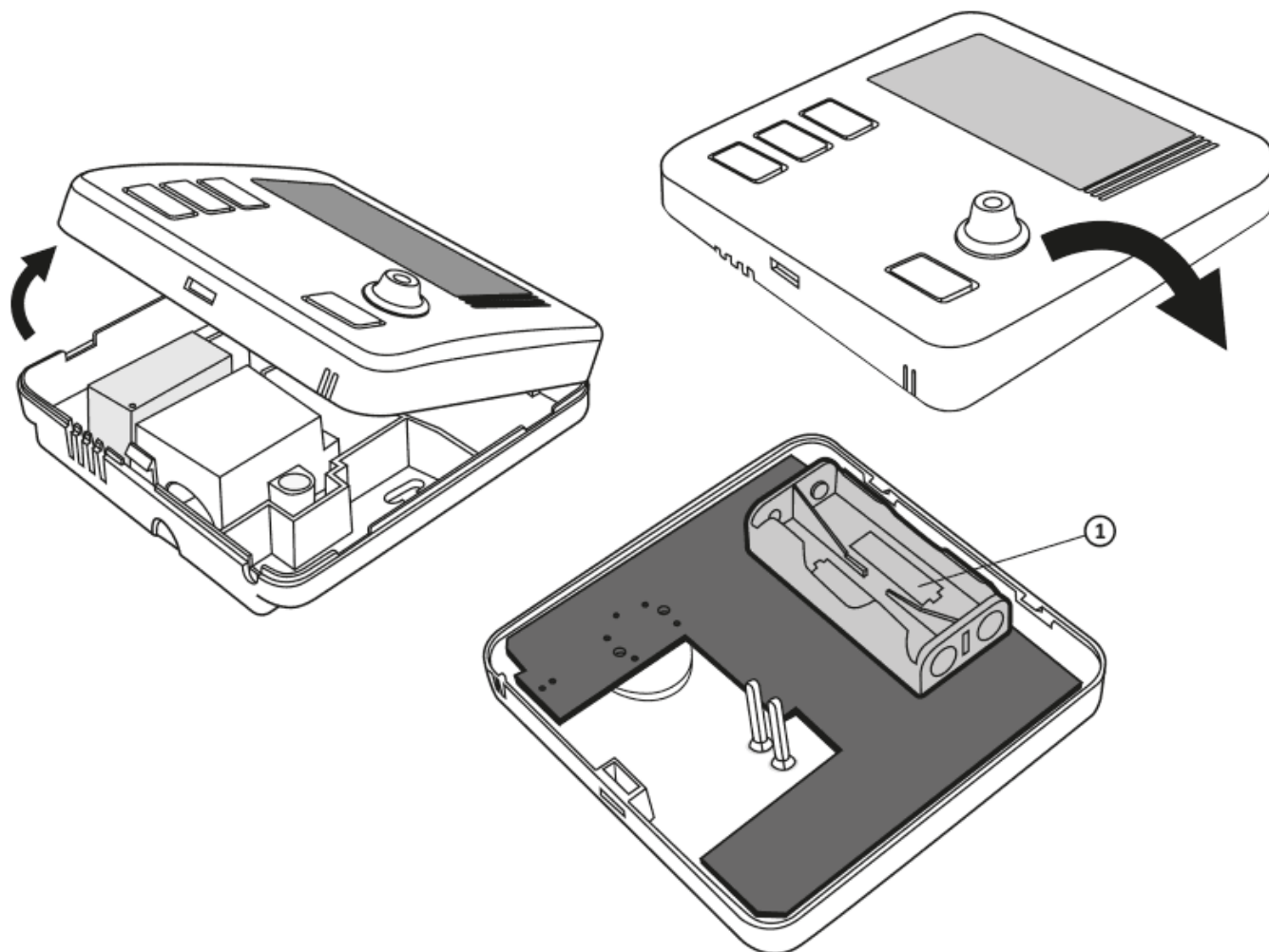

1. - Socket for AAA 1.5 V batteries

Insert two AAA 1.5 V batteries into the battery socket, making sure the battery terminals are aligned correctly.

NOTE:

After replacing the battery and installing the cover, we recommend pressing the **OK** button twice to stabilise the relay operation.

Mounting of AURATON Cetus - daily hard-wire thermostat

In order to fix the AURATON Cetus thermostat to the wall:

1. Remove the thermostat housing (*in a way shown in chapter "Connecting the wires to AURATON Cetus"*)
2. Drill two holes of 6 mm diameter in the wall (*the spacing of the holes should be determined by the rear part of the AURATON Cetus housing*).
3. Insert the wall plugs into the drilled holes.
4. Screw the rear part of the AURATON Cetus housing to the wall using the screws provided.
5. Put on the AURATON Cetus housing.

NOTE:

In the case of a wooden wall, there is no need to use wall plugs. Simply drill 2.7 mm diameter holes (instead of 6 mm), and screw the bolts directly into the wood.

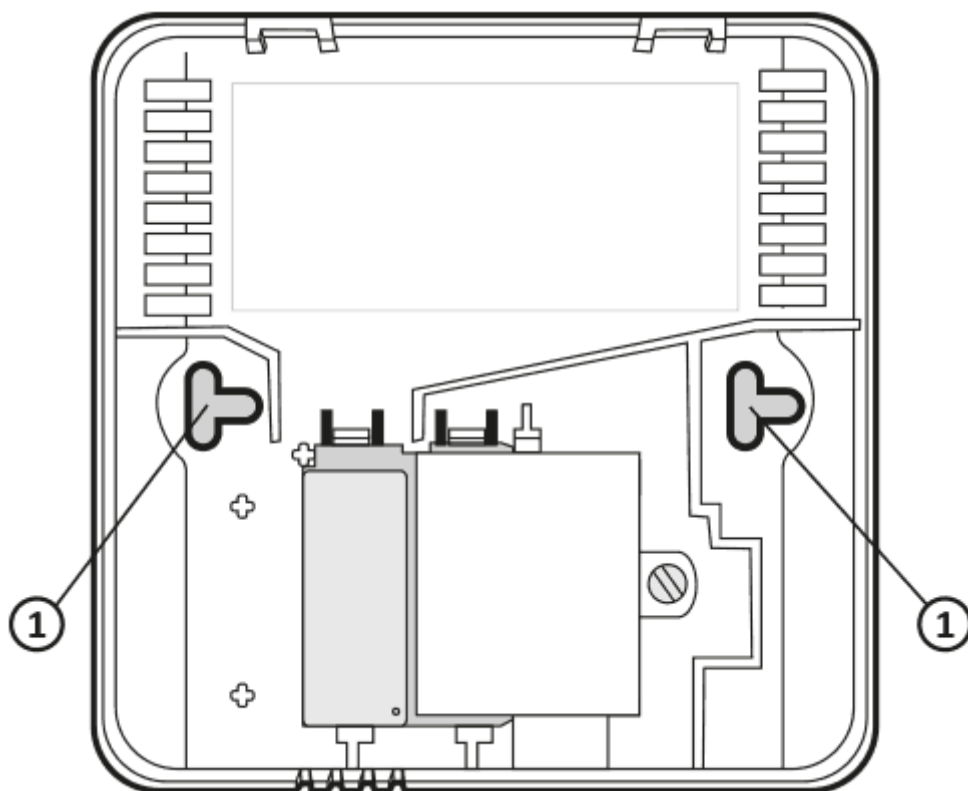

1. hole for fixing screw

Installing the housing: NOTE

When reattaching the front housing to the rear housing, pay attention to the pins that transfer the relay control.

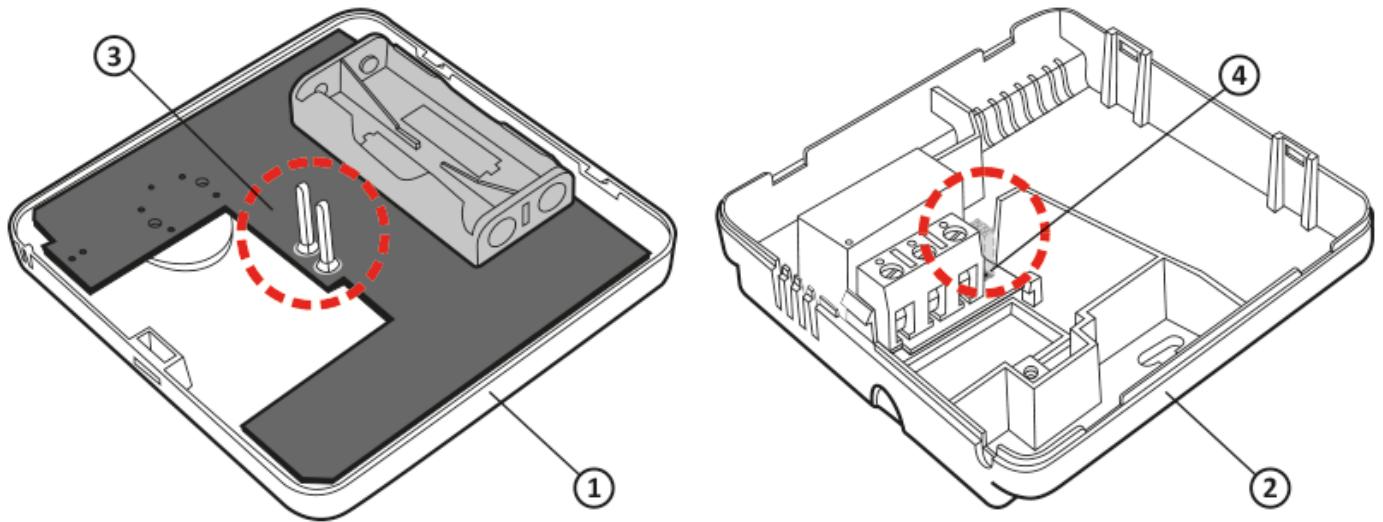

1. Front housing
2. Rear housing
3. Pins
4. Pin connector socket or the place where pins contact the board

NOTE:

When assembling the housing, make sure that the connection “pins” are not bent and are in place on the relay board. This is critical to the proper operation of the thermostat.

First start-up of AURATON Cetus

When the batteries are properly inserted in the sockets, the LCD display will show all segments for a second (display test), followed by the software version number (e.g. F12).

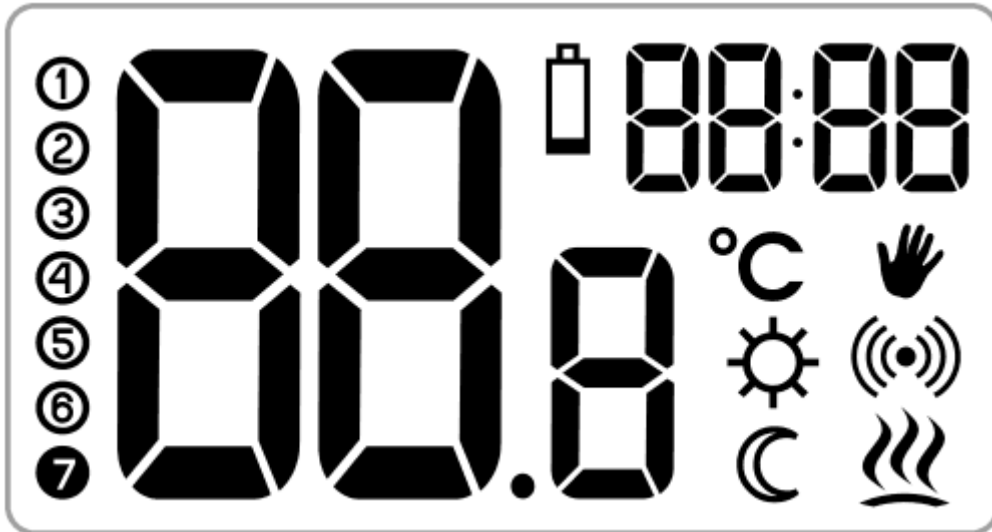

After a moment, the current room temperature is automatically displayed. AURATON Cetus is ready for operation.





Temperature setting

NOTE:

The first press of any function key always turns on the backlighting, and only the next press calls up the key function.

After a moment, the current room temperature is automatically displayed. AURATON Cetus is ready for operation. In order to set the desired temperature in the normal operation mode, one should:

1. Press the  button. The segment displaying the current room temperature will start flashing.
2. By turning the knob to the left or right, with an accuracy of 0.2 °C, we set the desired room temperature.
3. Confirm the selection with 

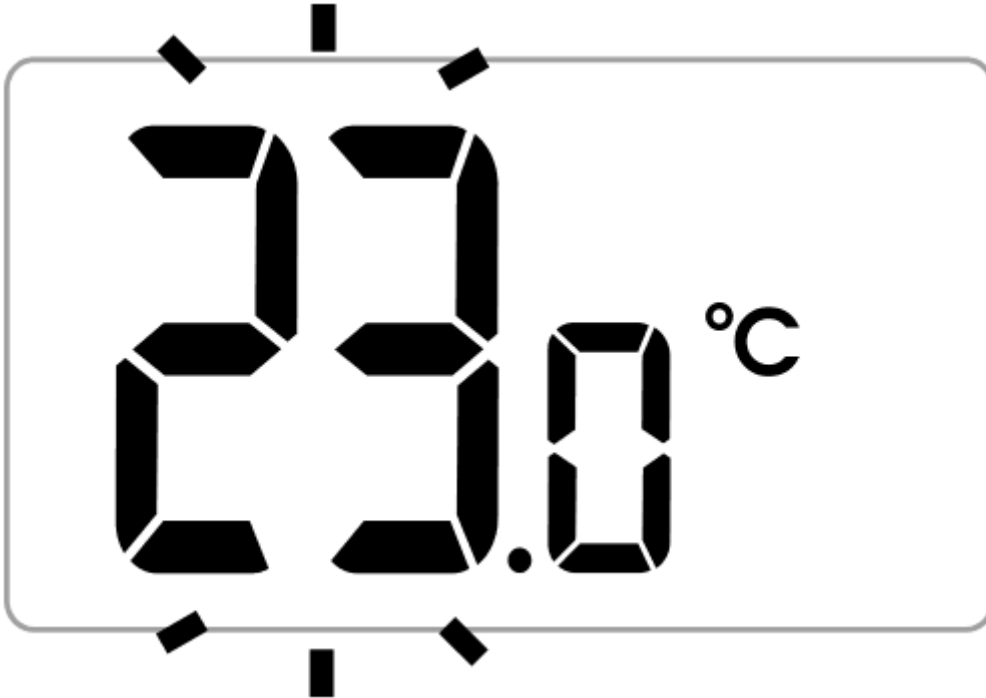



Setting the “temporary temperature lowering” mode

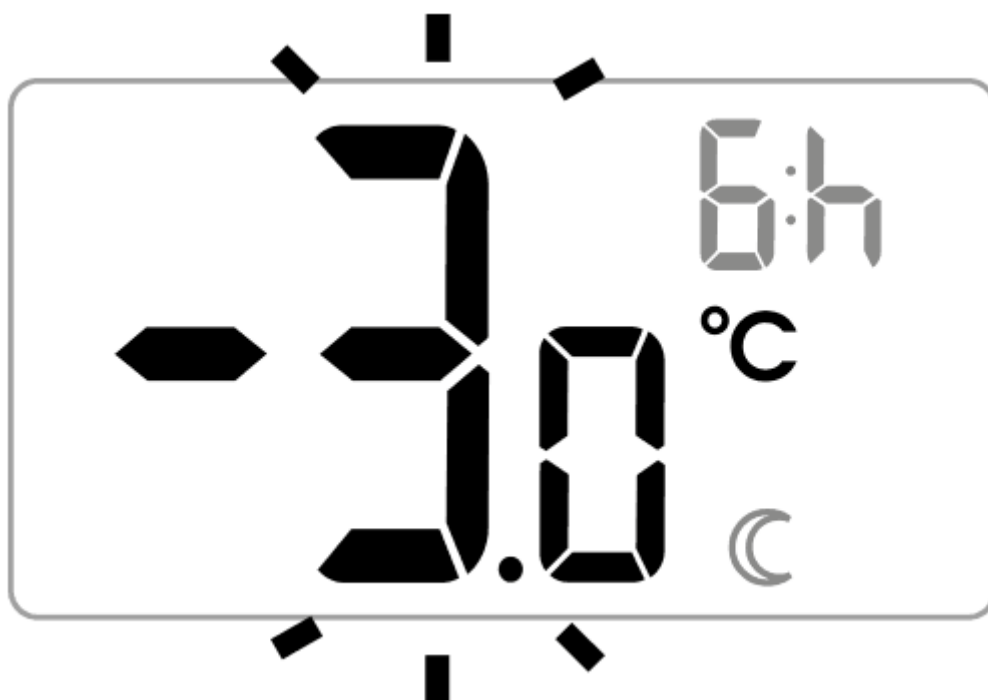

If, for various reasons, we would like to lower the temperature in the room at a certain time every day, it is possible to temporarily reduce it by up to 5 °C. In order to do that one should:

1. Press and hold the button for 3 seconds . On the display there will appear the moon (☾), hour field (e.g. 6h), and the segment responsible for showing the temperature will go into edit mode and start flashing.





2. Turn the knob to the left or right to set the temperature lowering by 1 °C to 5 °C. Confirm the selection with .



3. The hour field on the display will go into edit mode, and will start flashing. Using the knob again, set the number of hours for which the programmed lowered temperature is to remain valid. You can choose from 1 to 12 hours. Confirm the selection with .
4. For a selected number of hours, AURATON Cetus will be in the “temporary temperature lowering” mode, and will start it up every day at the same time.

NOTE:

After the set hour time, AURATON Cetus will return to the basic temperature setting. Instead of the moon () , the sun () will appear on the screen.

NOTE:

Temporary temperature lowering mode always starts when the function edit is confirmed. This means that any temporary temperature reduction should be programmed at the time you want it to occur.

Deactivating the “temporary temperature lowering” mode

AURATON Cetus will perform the programmed mode of temporary temperature lowering every day at the same time until the temporary lowering is deactivated. To switch off, press the

                
      .

“Manual” mode setting



If you wish to suspend the implementation of the normal or temporary reduced temperature for a certain period of time, you can set a “manual” program, valid for a maximum of 8 days. In order to do this you need to:

1. Press the  button.

The hand symbol () will appear on the display, and the segment responsible for showing the current temperature will go into edit mode, and will start flashing.

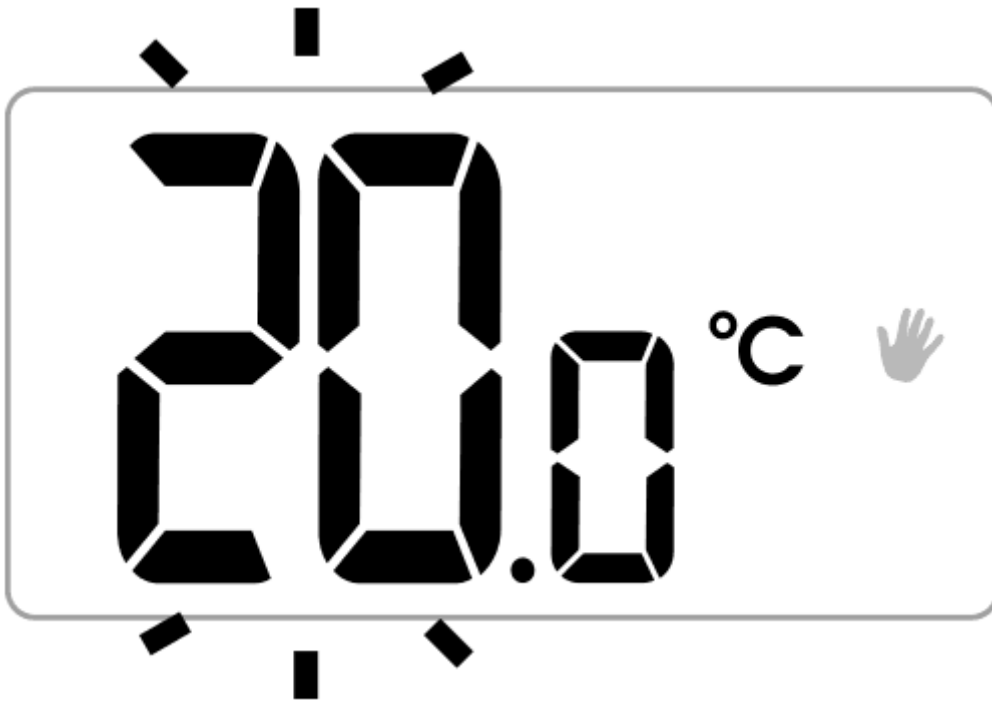

2. Turning the knob to the left or right sets the desired temperature value. Confirm the selection with .



3. The hour field on the display will go into edit mode, and will start flashing. Use the knob to select the number of hours for which the manual temperature setting should apply. Days are added or subtracted automatically when the 24-hour value is exceeded. A maximum of 7 days and 24 hours can be selected. Confirm your choice with .

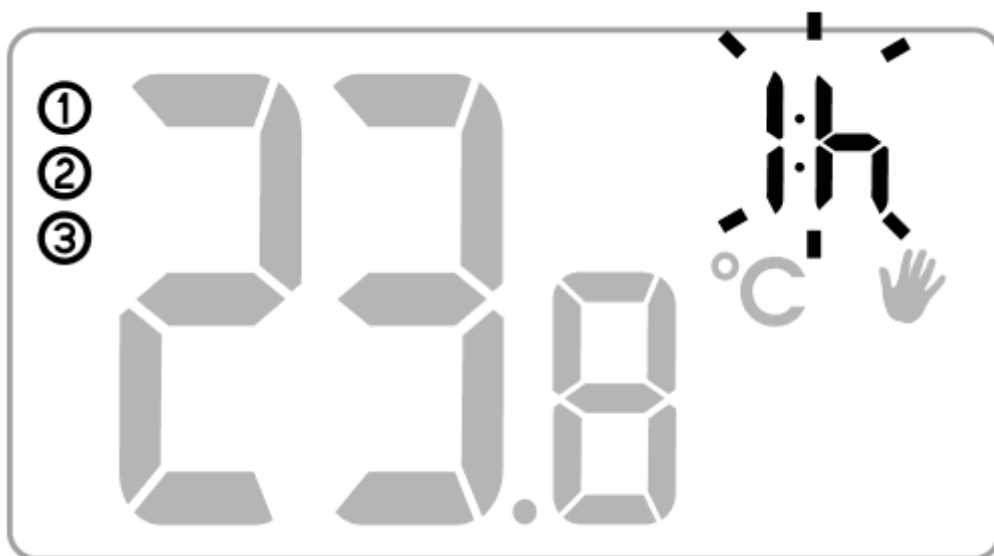

NOTE:

Manual mode is not self-repeating. After expiry of the programmed time, AURATON Cetus returns to the implementation of the previous temperature programs: normal mode and temporary temperature lowering mode, if the latter was previously planned.

Earlier deactivation of “manual” mode



AURATON Cetus will carry out the programmed manual mode until the programmed time expires. To deactivate “manual” mode earlier, press the  button again.

Checking the set temperature

Holding down the  key for a min. 2 seconds allows you to check the currently programmed thermostat temperature. Correctly performed actions will cause the display to show a flashing segment responsible for displaying the set temperature of the device. The function is active in each mode of AURATON Cetus operation.

FrostGuard function



AURATON Cetus is equipped with a special FrostGuard function protecting the room against possible freezing. This function is activated when **AURATON Cetus is switched off.**

With AURATON Cetus switched off, when the temperature in the room drops to 2 °C, the symbols () and () appear on the display, and the relay switches on. When the temperature rises to 2.2 °C, the display will turn off again, and the relay will disconnect the contacts.

Hysteresis change

The hysteresis is intended to prevent the executive device from switching on too frequently due to minor temperature fluctuations.

*For example, for the **HI 2** hysteresis, when the temperature is set to 20 °C, it will be switched on at 19.8 °C and switched off at 20.2 °C. For the **HI 4** hysteresis, when the temperature is set to 20 °C, it will be switched on at 19.6 °C and off at 20.4 °C.*

To enter the hysteresis change mode, hold down the ,  and  buttons simultaneously for 3 seconds.

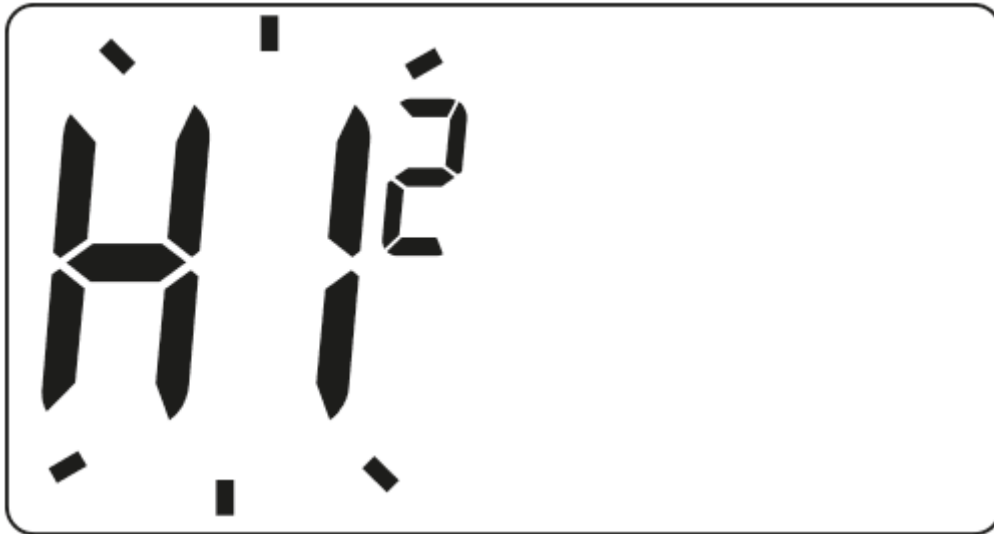

The hysteresis change mode is signalled by flashing HI. Turn the knob to the left or right to set the desired hysteresis.

HI 2 - $\pm 0,2$ °C (factory set),

HI 4 - $\pm 0,4$ °C,

HI P - PWM mode of operation (chapter " PWM mode of operation").

Confirm the selection with the  button. The thermostat will return to normal operation.

Pulse-Width Modulation operating mode

(PWM)

By changing the hysteresis settings (chapter "Configuration settings") you can enable the **PWM** mode. In this mode, AURATON Cetus cyclically switches on the heating device to minimize temperature fluctuations. AURATON Cetus checks the times of temperature rise and fall.

Knowing these values, AURATON Cetus switches the heating device on and off in such cycles to maintain the temperature as close to the setpoint value as possible.

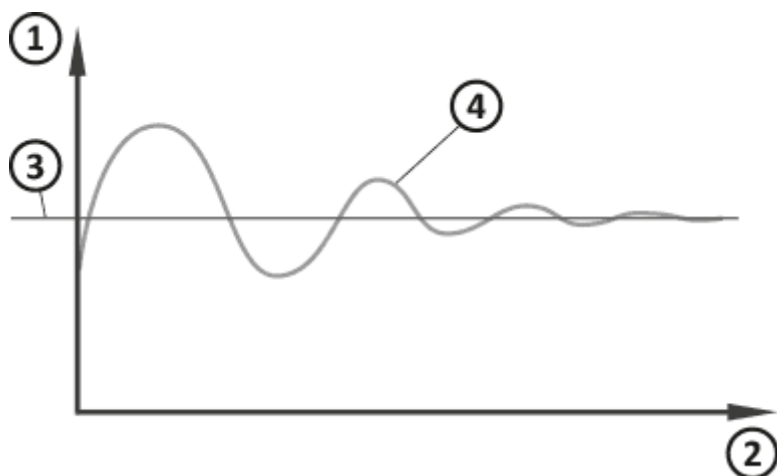



1. Temperature
2. Time
3. Setpoint temperature
4. Room temperature

NOTE:

In the PWM mode, AURATON Cetus can switch on the heating device despite the fact that the room temperature is higher than the setpoint temperature. This is due to the PWM algorithm seeking to maintain the setpoint temperature and anticipating the behaviour of the thermal system.

Notes

- AURATON Cetus can be switched on or off at any time by momentarily holding down the  button.

- The first press of any function key always turns on the backlighting, and only the next press calls up the key function. When using the knob, each step keeps the backlight working.
- If no button is pressed for 10 seconds during the programming of a function, it is equivalent to pressing the  button.
- After the relay is switched off (heating function), it can be switched on again not earlier than after 90 seconds.

Connection diagram of AURATON Cetus

NOTE:

Auraton Cetus can work with gas OR electric heating devices.

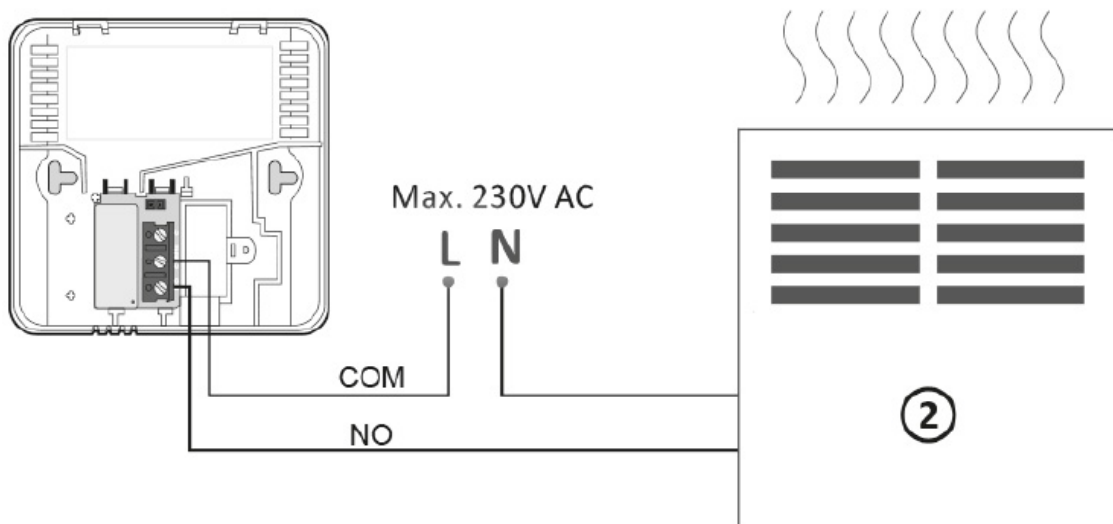
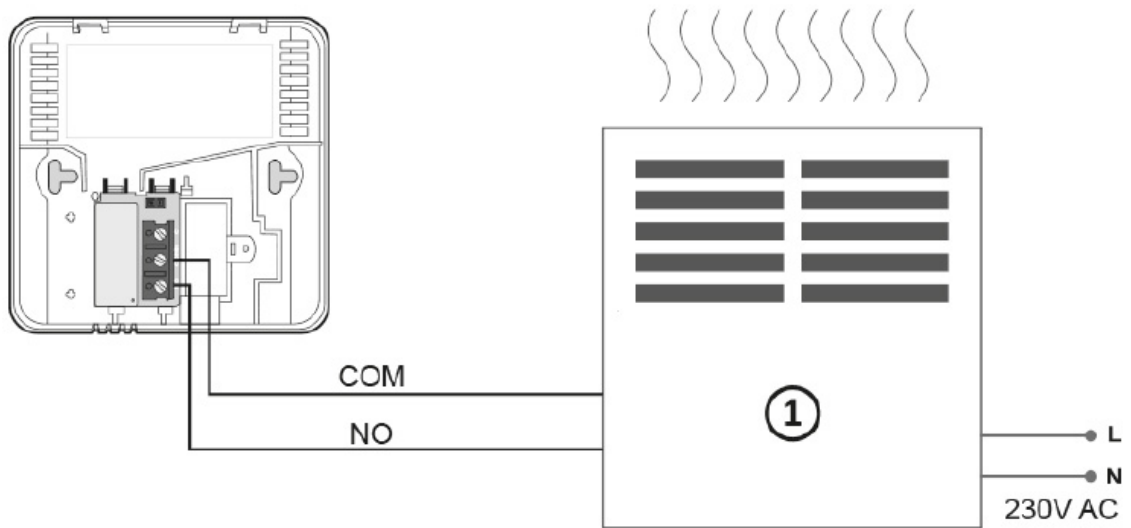

1. Heating device, *e.g. gas furnace*
2. Electric heating device (MAX 230 V AC, 16 A)

Cleaning and maintenance

- Clean the outside of the unit with a dry cloth. Do not use solvents (such as benzene, thinner or

alcohol).

- Do not touch the unit with wet hands. Doing so may result in an electric shock or serious damage to the unit.
- Do not expose the unit to excessive smoke or dust.
- Do not touch the screen with a sharp object.
- Avoid contact of the device with liquids or moisture.

Technical specifications

Power supply:	2 x AAA (2 x 1.5 V), alkaline
Working temperature range:	0 - 45 °C
Signalling the working status:	LCD display
Number of temperature levels:	1
Anti-freeze temperature:	2 °C
Temperature measurement range:	0 - 35 °C
Temperature control range:	5 - 35 °C
Temperature setting accuracy:	0.2 °C
Hysteresis:	±0.2 °C/±0.4 °C/PWM
Relay load capacity:	Max. 250 V AC, max. 16 A
Working cycles:	24-hour
Level of security:	IP20
Dimensions [mm]:	90 x 90 x 36

Disposing of the devices

The devices are marked with the crossed-out wheeled bin. According to European Directive 2012/19/EU and the Waste Electrical and Electronic Equipment Act, this kind of marking indicates that the equipment, after its operational life must not be disposed of together with other waste from households.

The user shall return it to a collection point for electrical and electronic



waste.

Contact and address of the manufacturer

LARS, ul. Świerkowa 14
64-320 Niepruszewo
www.auraton.pl

Download

- [User manual](#)
- [Declaration of conformity](#)