



## **AURATON Libra R**

User manual ver. 20220222

The document presents collected information on safety, assembly and use of Auraton Libra R.

---

### **Weekly, wireless thermostat (transmitter)**

AURATON Libra R (transmitter) is a weekly, wireless thermostat designed to work with the AURATON Aries and with the AURATON Fornax.



#### **3 independently adjustable temperatures**

Day, night, anti-freezing.



#### **9 independent temperature programs**

Including 6 user-modifiable programs.

#### **LCD**

#### **Backlit LCD display**

The backlit display allows you to supervise the operation of the device even in poorly lit rooms.

# Description of the AURATON Libra R

## weekly, wireless thermostat (transmitter)

There is a backlit LCD display, four function buttons and a temperature setting knob with an **OK** button on the front part of the thermostat's casing.

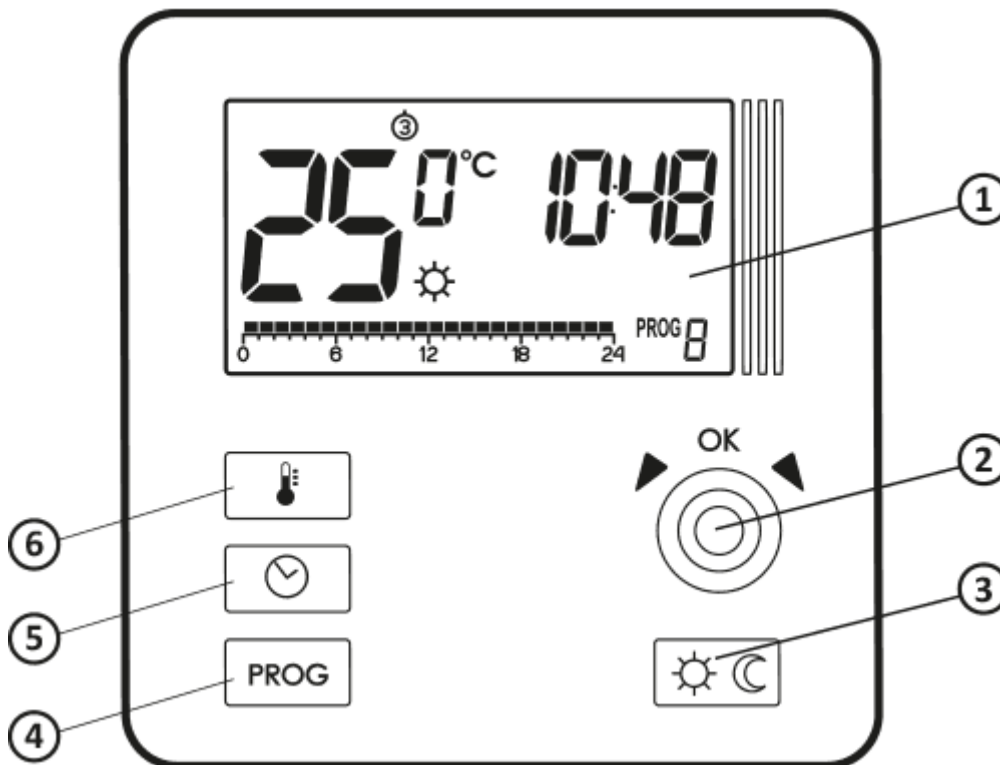

1. LCD display
2. setting knob with integrated **OK** button
3. mode selection buttons:
  - ☀ - day mode - comfort,
  - ☾ - night mode - economic
4. selection button
5. date/time/day of week setting button
6. temperature setting button

## Display

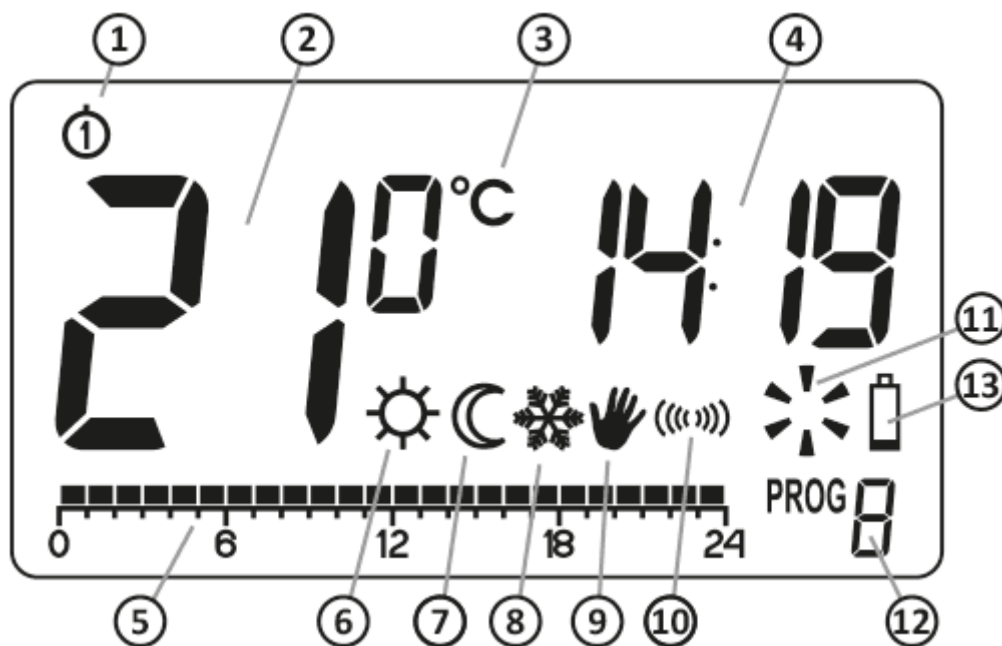

1. **Day of the week** (①-⑦) - Indicates what day of the week it is. Each day is assigned a number.
2. **Temperature** - AURATON Libra R displays the temperature of the room in which it is installed in normal operation mode.
3. **Temperature unit** - tells you that the temperature is displayed in Celsius degrees (°C).
4. **Clock**  
Time is displayed in a 24-hour system.
5. **Timeline**  
Program progress indicator. The timeline is divided into 24 segments, each of which corresponds to one hour. It shows how a given program is implemented. (see chapter "Timeline")
6. **Day mode indicator** (☀️)  
Indicates that AURATON Libra R is operating in the day mode. (patrz rozdział: „Programowanie temperatur”)
7. **Night mode indicator** (🌙)  
Indicates that AURATON Libra R is operating in the night mode. (see chapter "Temperature programming")
8. **Anti-freezing mode indicator** (❄️)  
Indicates that AURATON Libra R is operating in the anti-freezing mode. (see chapter "Anti-freeze mode")
9. **Manual control indicator** (👋)  
Appears when no program is used. (see chapter "Manual control mode")
10. **Broadcast symbol** (📡)  
Indicates communication with the receiver.
11. **AURATON Libra R activation indicator** (⚡️)  
Segment giving information about the operating status of AURATON Libra R. Visible when the

regulator is turned on.

12. **Program number**

Indicates the number of the currently running program. (see chapters "Factory programs" and "Weekly programming")

13. **Dead batteries (🔋)**

The indicator is visible when the minimum permissible battery voltage level is exceeded. The batteries need to be replaced as soon as possible.

**IMPORTANT:**

In order to maintain any programmed parameters, the battery replacement operation should not exceed 30 seconds.

### Choosing the right location for AURATON Libra R

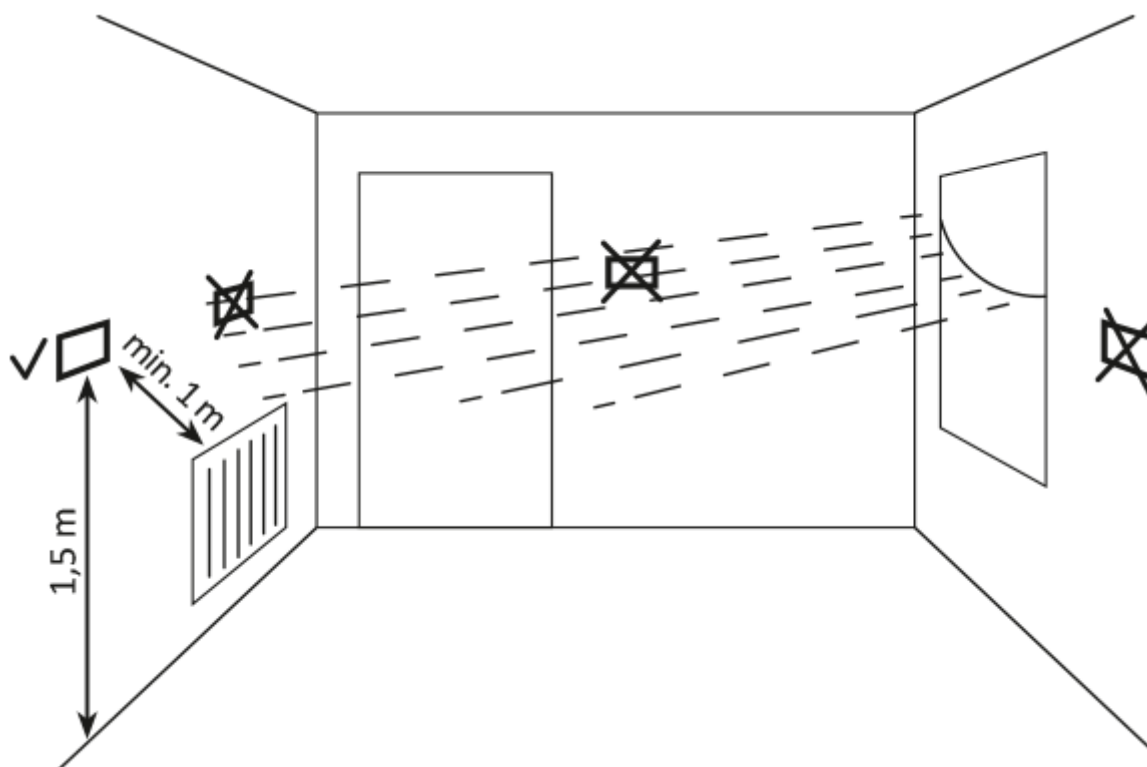

The correct operation of AURATON Libra R is largely influenced by its location. Using the device in a place with no air circulation or a place with direct sunlight may result in incorrect temperature control. AURATON Libra R should be installed on the internal wall of a building (a partition wall), in an environment with free air circulation. You should avoid proximity to heat-emitting devices (TV,

heaters, refrigerators) or locations exposed to direct sunlight. The vicinity of doors and exposing AURATON Libra R to possible vibrations may also cause problems with proper operation of the device.

## Battery replacement

The battery compartment is located inside AURATON Libra R in the front of the casing. To install the batteries, remove the casing of AURATON Libra R as shown in the figure below:

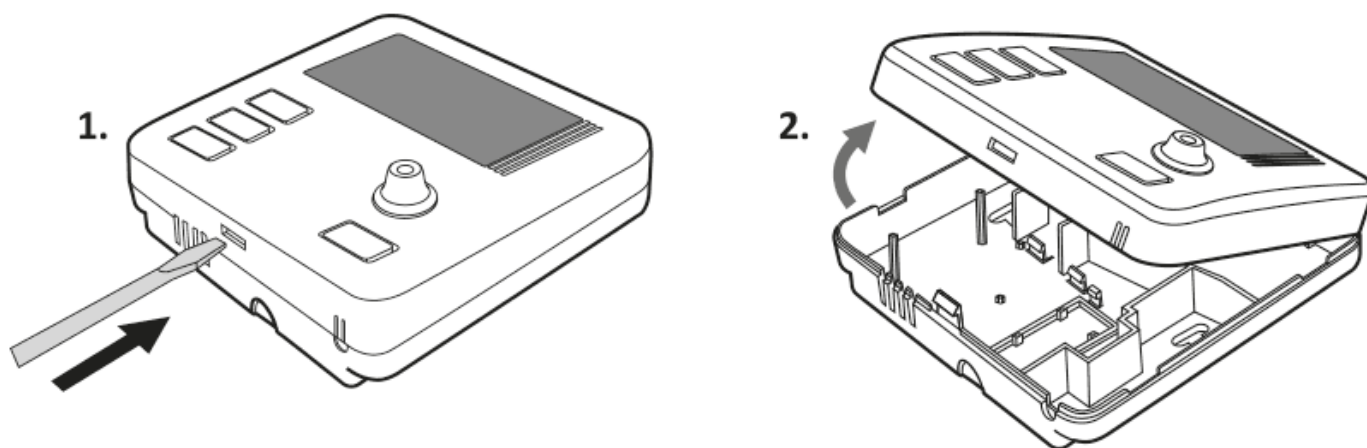

**IMPORTANT:**

We recommend using alkaline batteries to power AURATON thermostats. Do not use “rechargeable batteries” because their rated voltage is too low.

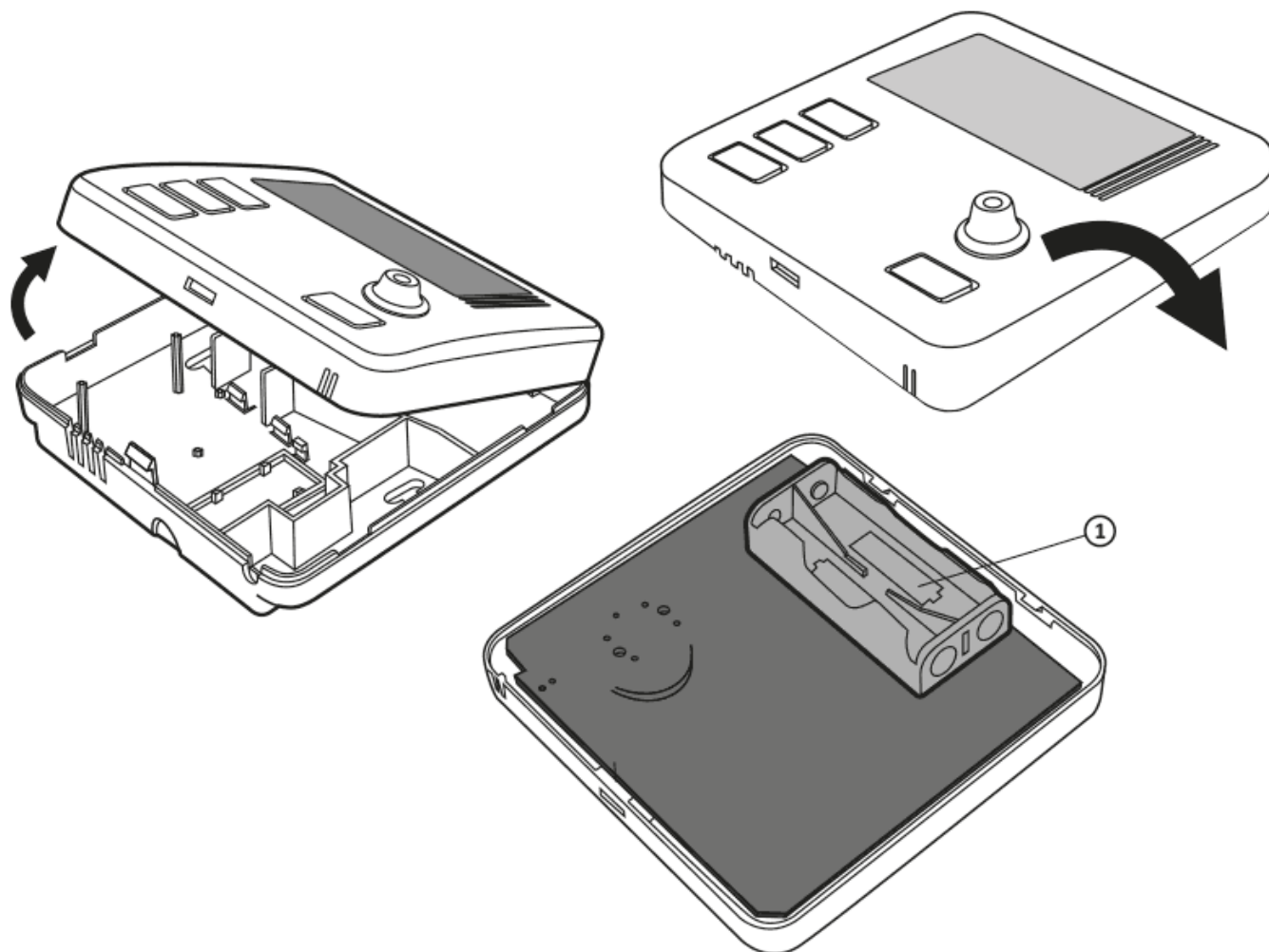

1. AAA 1.5 V battery socket

Insert two 1.5 V AAA batteries into the battery compartment, paying attention to the correct polarity of the batteries.

**UWAGA:**

After replacing the battery and assembling the cover, we recommend pressing the OK button twice to stabilise the relay operation.

## Mounting AURATON Libra R - the weekly, wired thermostat

In order to mount AURATON Libra R on the wall:

1. Remove the casing (as shown in the "Battery Replacement" section)
2. Drill two holes with a diameter of 6 mm in the wall (mark the spacing between the holes using the rear part of the AURATON Libra R casing).
3. Put wall plugs in the drilled holes.
4. Fix the rear part of the casing of AURATON Libra R to the wall using the screws included in the kit.
5. Put the casing on.

**IMPORTANT:**

In the case of a wooden wall, there is no need to use wall plugs. It is enough to drill holes with a diameter of 2.7 mm (instead of 6 mm) and screw the screws directly into the wood.

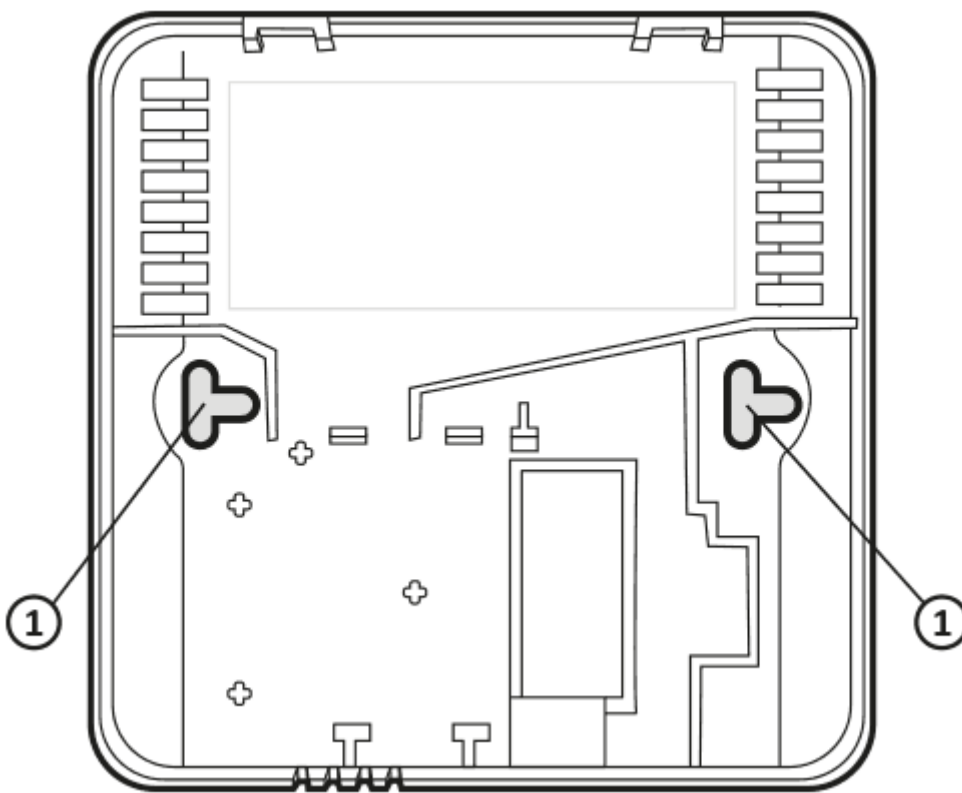

1. hole for fastening screw

## Turning AURATON Libra R on for the first time

After inserting the batteries correctly into the battery compartment, the LCD screen will display all the segments for a second and then the software version number.

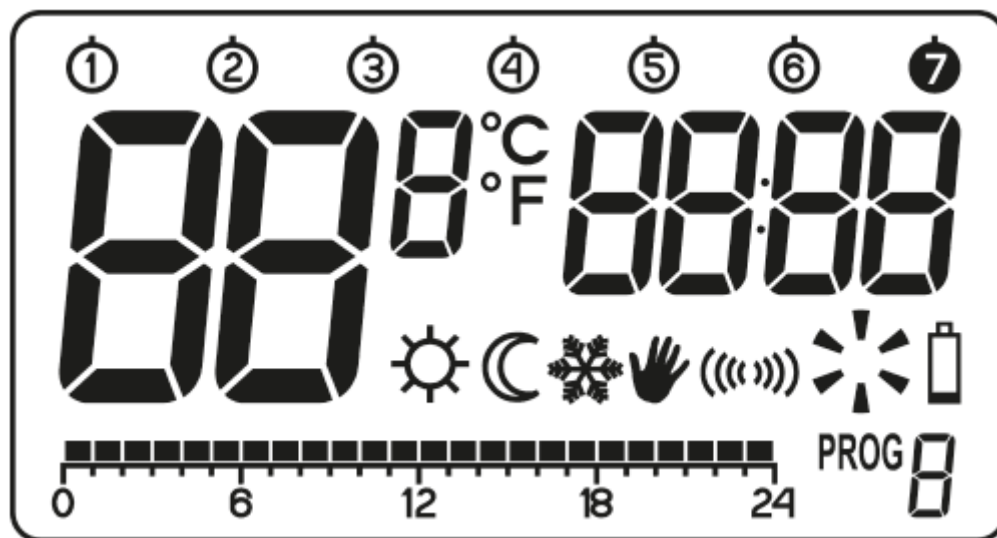

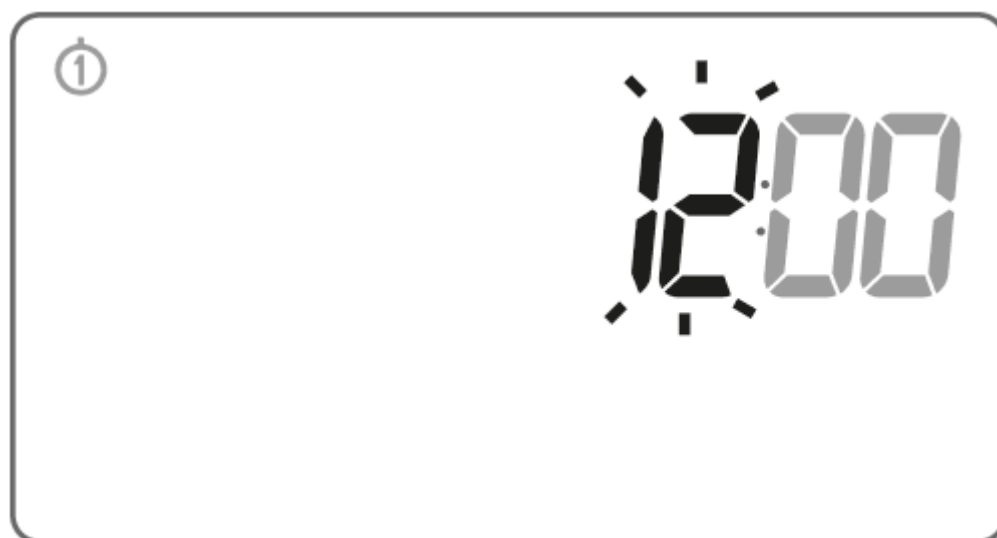

After a while, AURATON Libra R will automatically switch to the time setting mode. A flashing item on the screen means that the device is currently in the edit mode. Turn the knob to the left or right to set the required hour and confirm using the **OK** button.



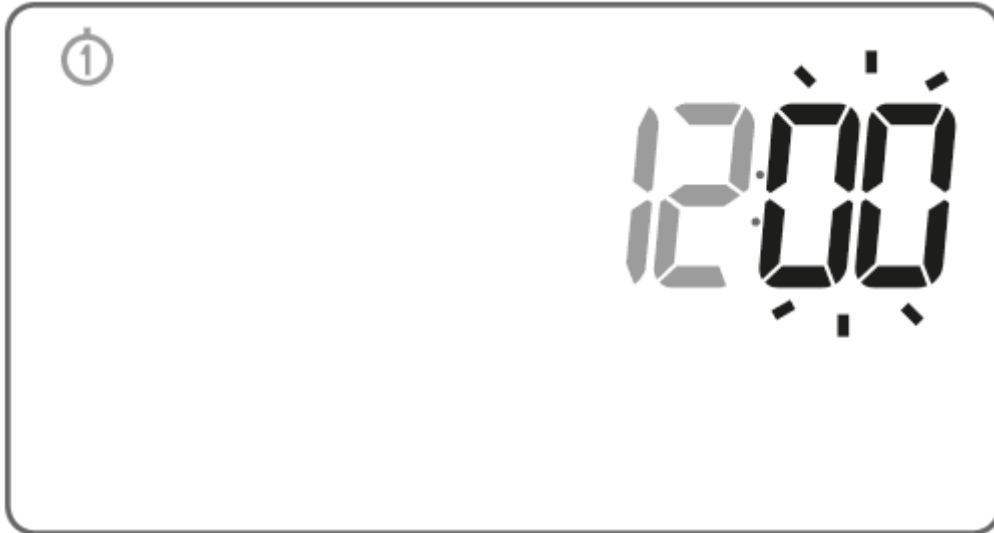

Turn the knob to the left or right to set the correct value on the minute segment and confirm using the  button.



A flashing symbol of the day of the week appears in the upper left corner. Turn the knob to the left or right to set the day and confirm the selection using the  button.



**IMPORTANT:**

If no button is pressed for 60 seconds in the initial edit mode, 12:00 o'clock and Monday, as the day of the week, will be set automatically.

**IMPORTANT:**

When programming any other functions, not pressing any button for 10 seconds is equivalent to using the  button.

## Setting the clock and day of the week

To set the clock:

Press the  button. The hour segment on the display will start flashing.

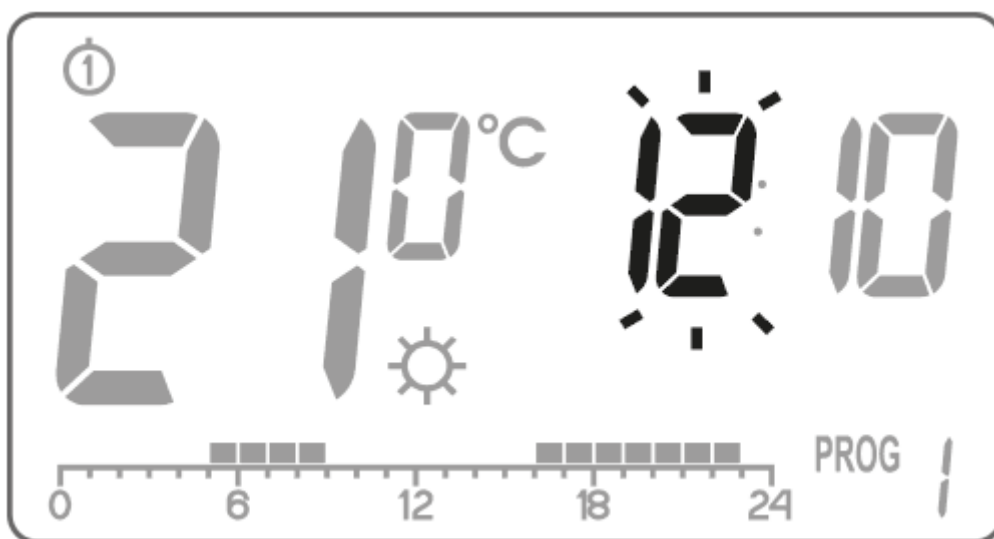

Turn the knob to the left or right to set the required hour and confirm with using the  button.

Turn the knob to the left or right to set the correct value on the minute segment and confirm using the  button.

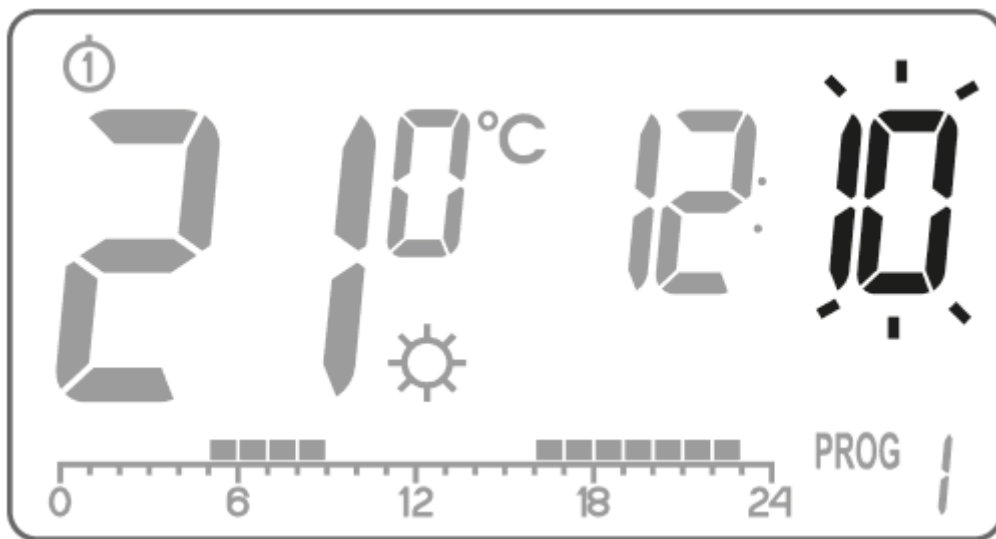

A flashing symbol of the day of the week appears in the upper left corner. Turn the knob to the left or right to set the day and confirm the selection using the  button.

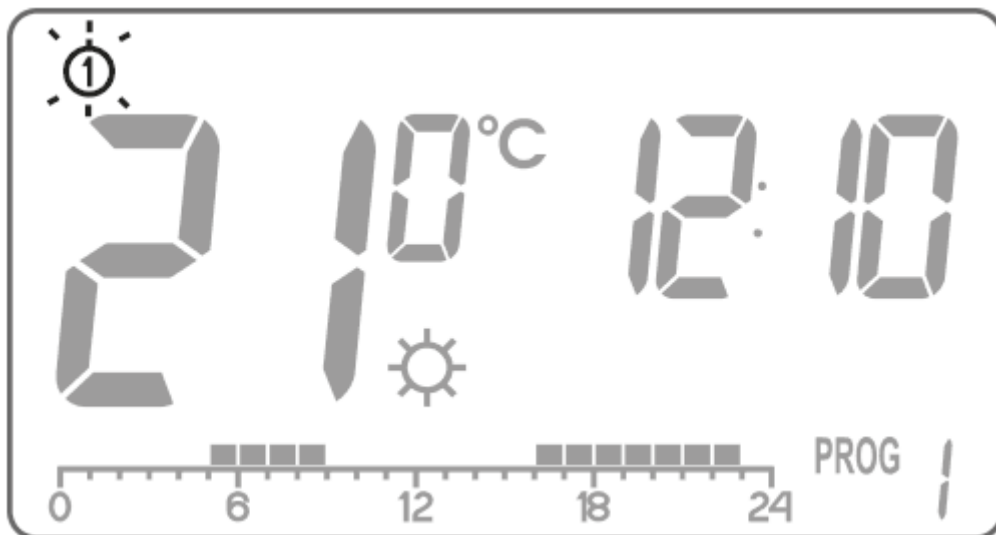

**IMPORTANT:**

You can also switch by pressing the  button.

## Default program setting

- **Monday - Friday:**

The heating device maintains the day temperature (☀) from **05:00 to 8:00 A.M.** and from **3:00 to 11:00 P.M.**

- **Saturday - Sunday:**

The heating device maintains the day temperature (☀) from **06:00 A.M. to 11:00 P.M.**

- **default temperature settings:**

☀ day temperature - 21,0 °C

🌙 night temperature - 19,0 °C

❄ anti-freeze temperature - 7,0 °C

## Programming day and night temperatures

AURATON Libra R allows you to program 2 types of temperature:

- Day temperature (☀) - from 5 to 30°C
- Night temperature (🌙) - from 5 to 30°C

To set one of the temperatures above:

1. Press the  button.





The display will show the currently set temperature with one of the two symbols:

☀ - **day temperature;**

🌙 - **night temperature.**



3. Turn the knob to the left or right to set the desired temperature value.

- Pressing the  button will switch the edit mode between the day and night temperatures (, ).
- After setting the temperatures, confirm using the  button.

**IMPORTANT:**

The night temperature setting can be equal to or lower than the day temperature. It is impossible for the night temperature to be higher than the day temperature.



## Introduction to programming

### Timeline

The timeline on the LCD display is divided into 24 sections. Each of them symbolizes 1 hour of the day. Black rectangles above the timeline mean that the day temperature has been programmed for specific hours, and that there is no night temperature.

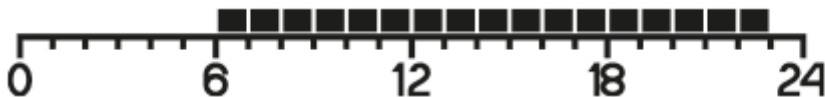
Example:



The figure above shows that from 6.00 A.M. to 11.00 P.M. Auraton Libra DS will control the heating device in such a way that the room temperature will be day temperature (). AURATON Libra R will switch to night temperature from 11.00 P.M. to 6.00 A.M. (.

## Factory programs

In order for AURATON Libra R to know when to turn on the day and night temperatures, you should be set to an appropriate program for each day of the week. For this purpose, you can use one of the three factory programs (from 0 to 2):

### Program no. 0 - anti-freezing ❄️

Unmodifiable factory program. Designed for all-day anti-freezing temperature setting.

### Program no. 1 - weekly

Unmodifiable factory program. Sets day temperature from 5:00 to 8:00 A.M. and from 3:00 to 11:00 P.M.

### Program no. 2 - weekend

Unmodifiable factory program. Sets day temperature from 6:00 A.M. to 11:00 P.M.

### Programs no. 3, 4,....., 8 - user-defined programs

Programs from 3 to 8 are user-defined programs. They can be freely modified and adapted to specific requirements.

## Programming

### Weekly programming

To program AURATON Libra R, set the day temperature intervals for individual days of the week. At other time, night temperature will be set.

*Sample AURATON Libra R setting from Monday to Sunday. Outside the intervals programmed, the night temperature will be set.*

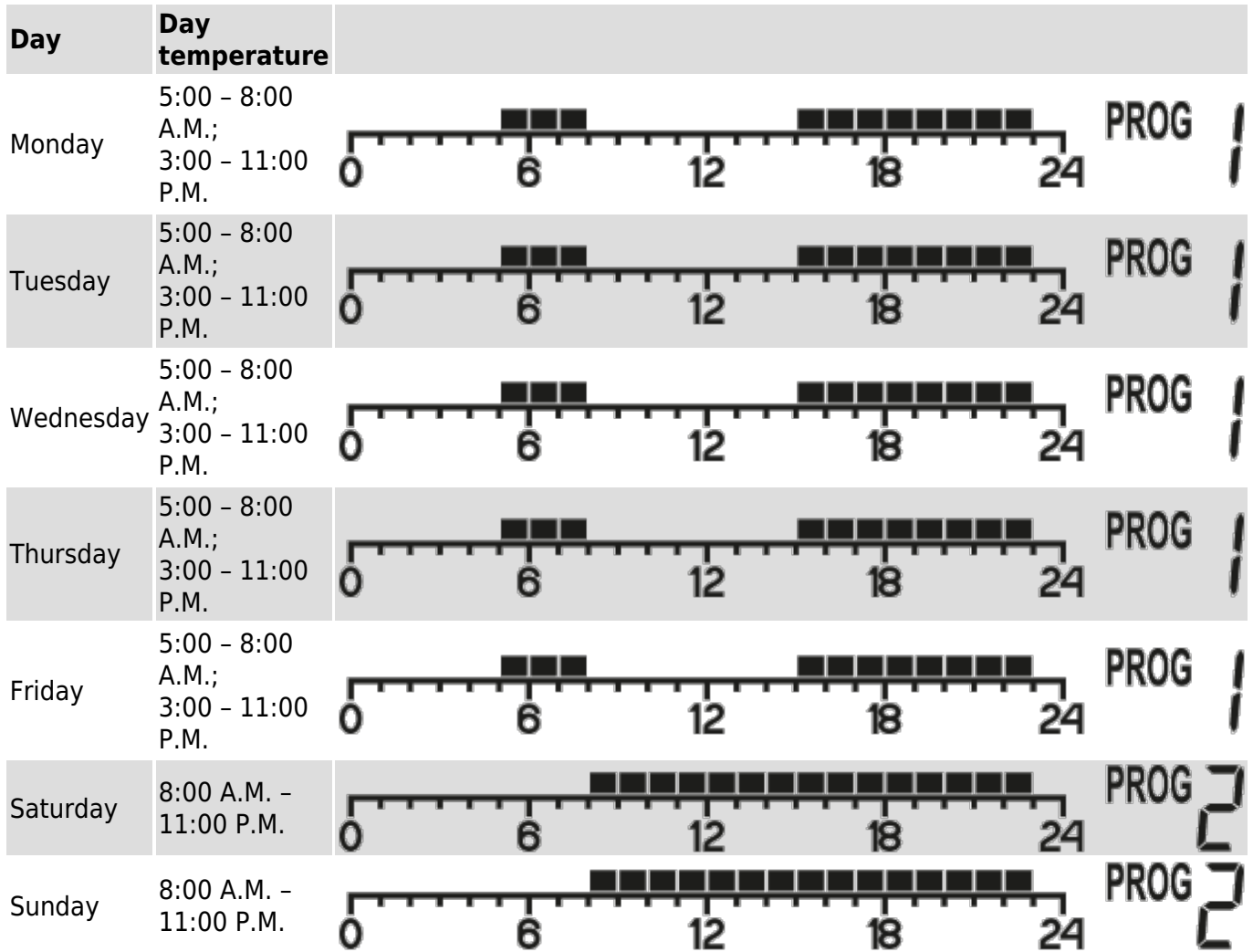



## Program selection

To set the program:

Press the **PROG** key. Program number segment will start blinking.

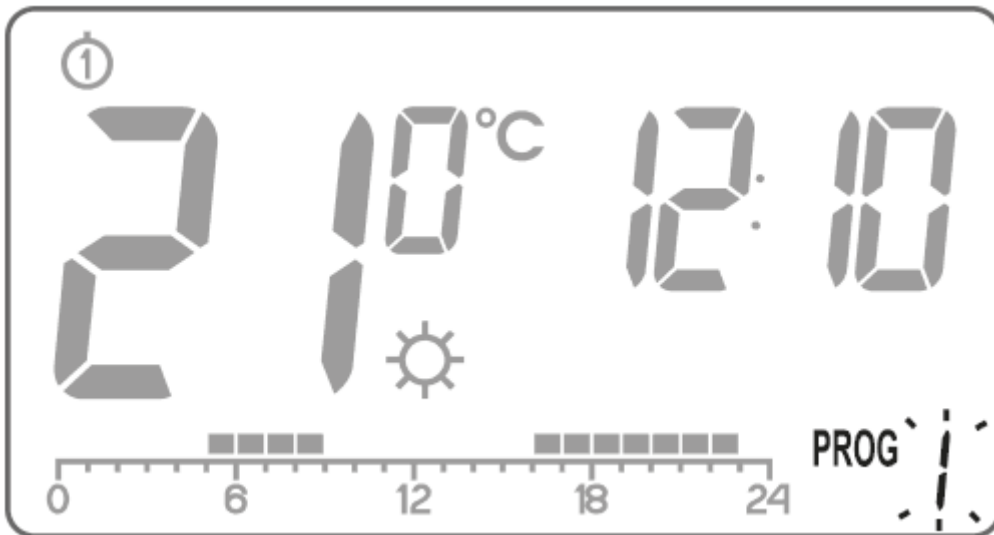



Press the  key as many times as required to set the day of the week for the program.

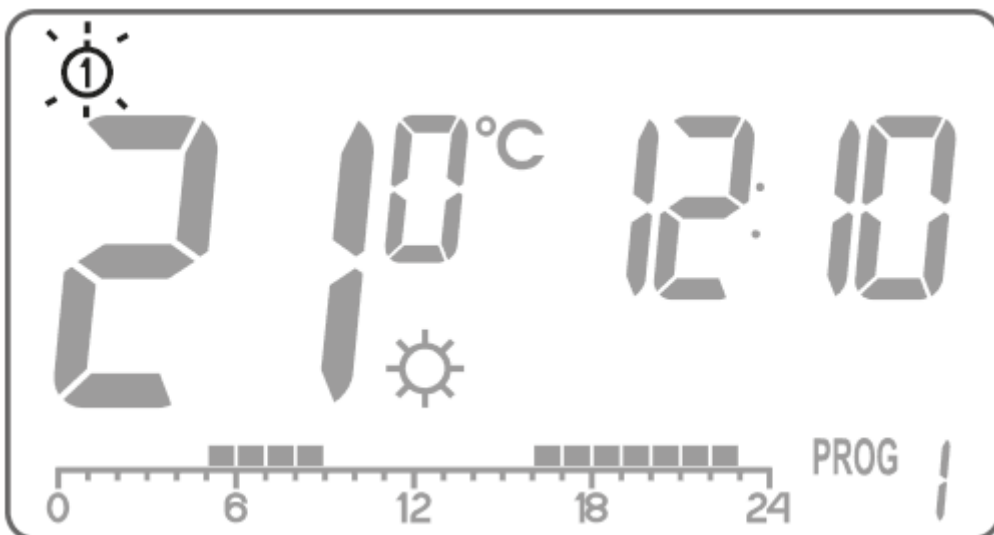

Press the **PROG** key several times and select the program number requested. Programs **0-2** are factory-set, programs **3-8** can be edited.

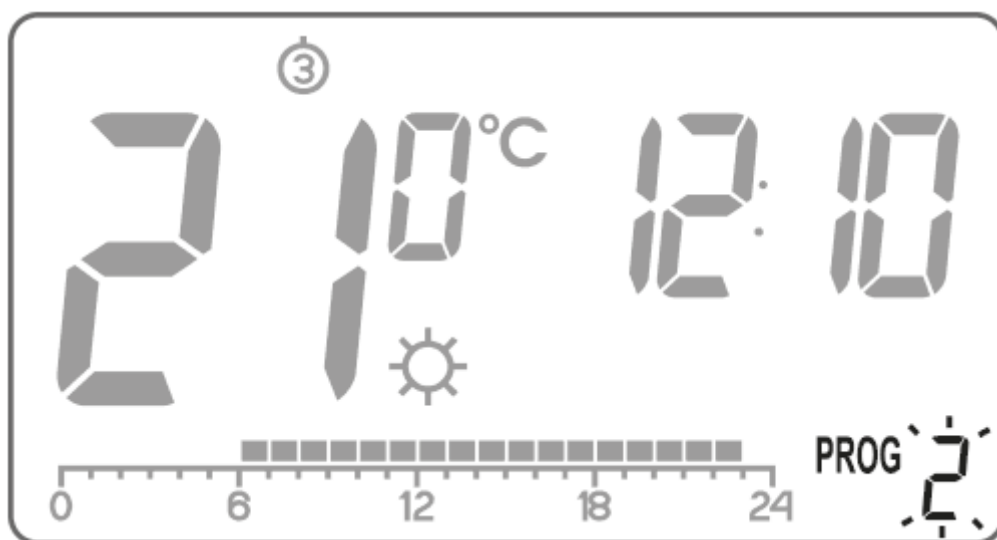



4. Confirm selection pressing the **OK** key.
5. Repeat the procedure for the following days of the week.

## **Modifying user-defined programs**

To set the program:

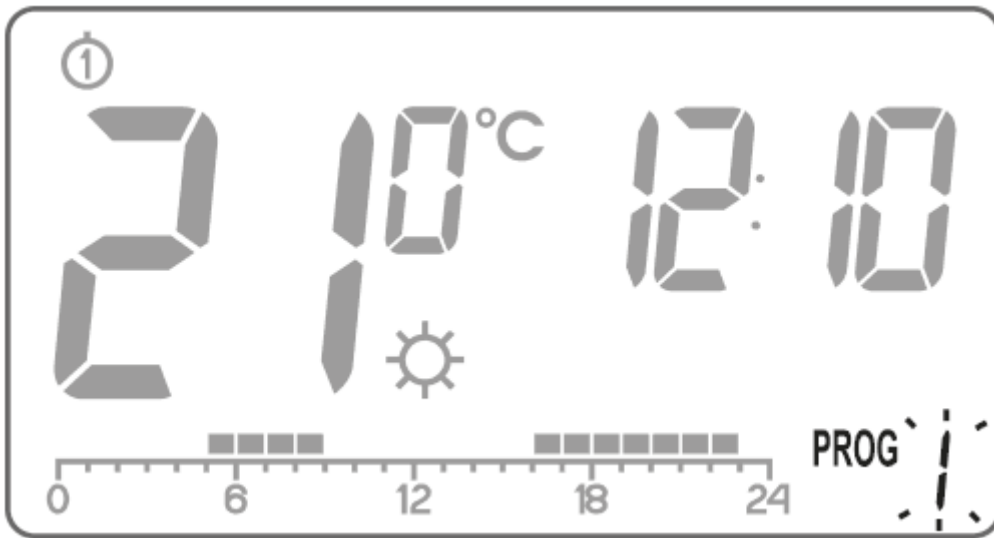
Press the **PROG** key. Program number segment will start blinking.



Press the  key as many times as required to set the day of the week for the program.

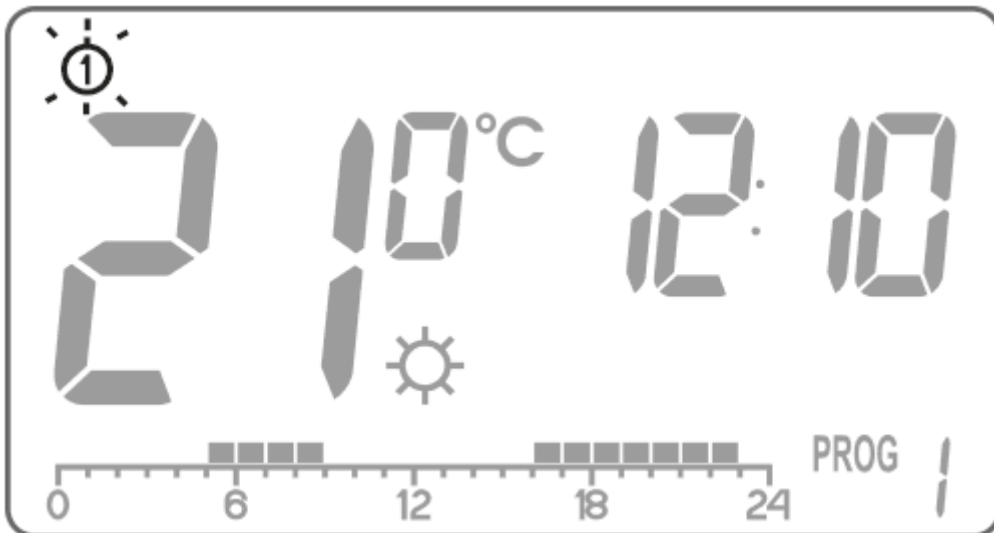

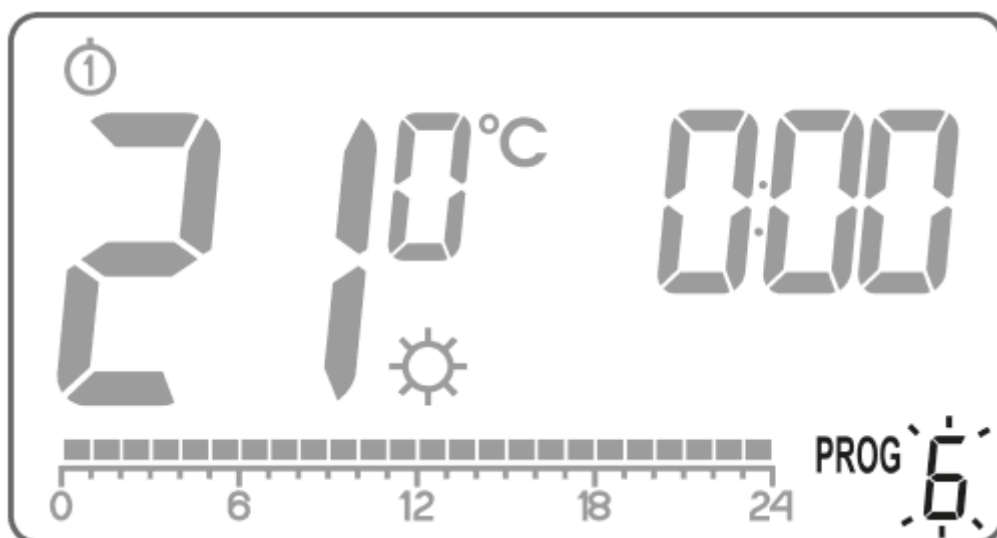

Press the **PROG** key several times to select the program number required. Programs **0-2** are factoryset, programs **3-8** can be edited.



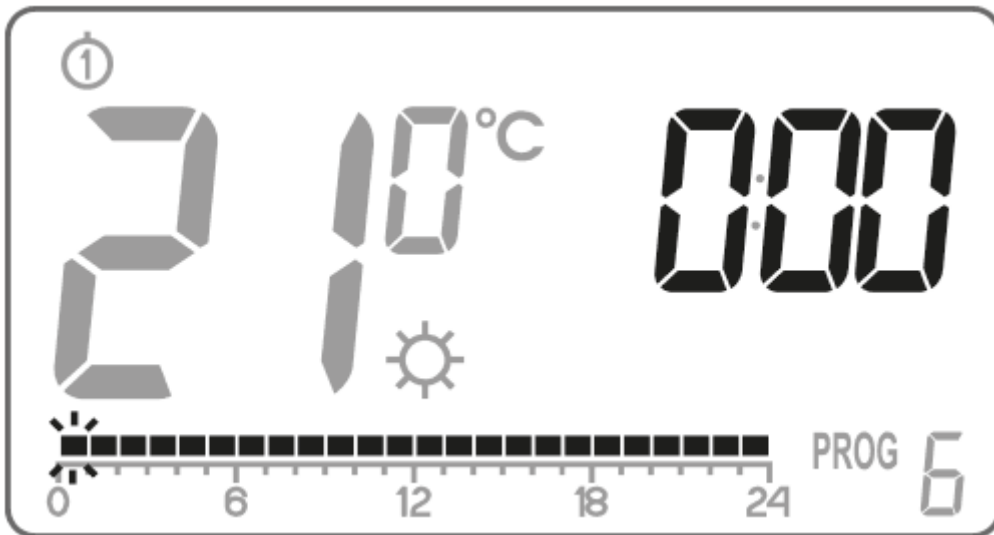

All (24) black rectangles will appear on the timeline. Each of them symbolises 1 hour. A visible rectangle indicates day temperature set for the given time. If no rectangle is displayed, night temperature is set.

Blinking rectangle indicates the point of the timeline which is modified.

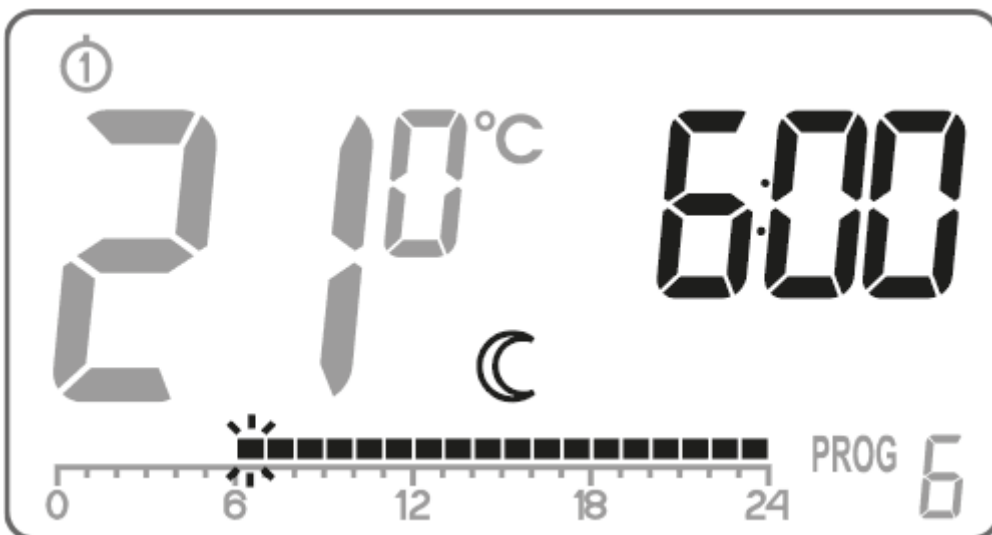

Press the  key to select day (rectangle on) or night temperature (no rectangle). Then, select the time interval for the temperature selected with the knob.



By pressing the  key and selecting time interval the entire program is modified.

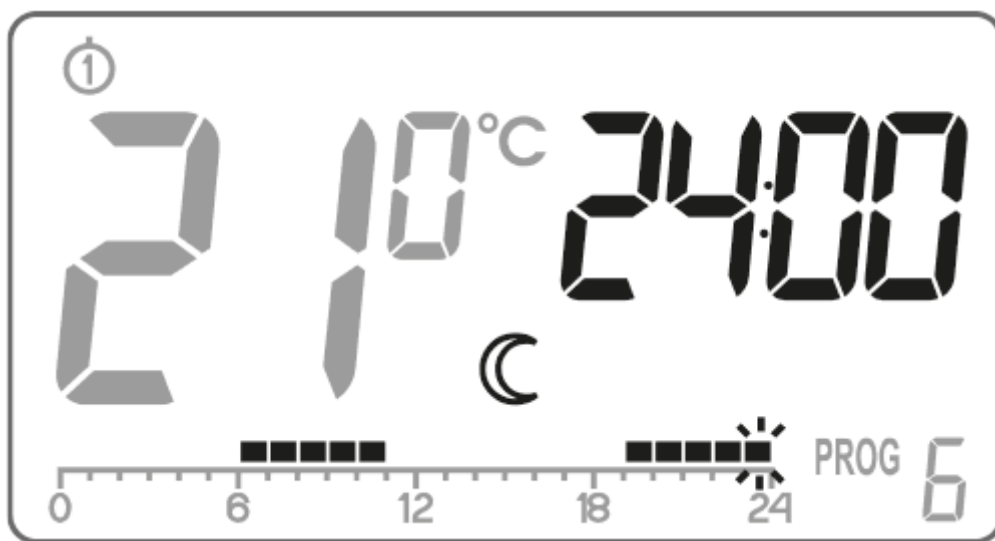

7. Confirm selection with the  key.

**NOTE:**



**Any modified program for a specific day can also be selected and implemented during another day of the week.**



## Manual control



### Option 1:



If, for some reason, you want to stop the current program at a given moment and extend the day or night temperature, you can do it manually, but for not longer than 24 hours. To do this you should:



Hold the  button for 3 seconds. Then, using the knob, select the number of hours of manual operation (24 hours at the most) and confirm the setting using the  button.

AURATON Libra R will wait until you choose one of the two temperatures which it should maintain (day or night). The change is made by using the  button or the knob. Confirm the selection using the  button.





### Option 2:

If you want to suspend the execution of a given program, e.g. due to a party lasting longer than expected, but AURATON Libra R has already started lowering the temperature for the night (the  symbol has appeared on the display), you should:

Press the  button, the display will show the symbols of a  and the . The day temperature will then be maintained until the next temperature change carried out by the program.

To withdraw the above-mentioned action press the  button. The  symbol will disappear from the display.

Similarly, if the program is using the day temperature but you want it to implement the night temperature immediately, you should:

Press the  button. The display will show the symbols of a  and the . The night temperature will then be maintained until the next temperature change carried out by the program. To withdraw the above-mentioned action press the  button. The  symbol will disappear from the display.

## Anti-freezing temperature





In the event of being away for a long time, it is possible to turn on the anti-freezing temperature mode. It allows you to avoid the unpleasant consequences of water freezing in the heating system by automatically setting the temperature to 7 °C. To set the anti-freezing program, simply select **program 0** for the desired day of the week.

## Pairing the AURATON Libra R weekly, wireless thermostat (transmitter) with the AURATON Fornax heating or air-conditioning device controller (receiver)

After connecting to the mains, switch the receiver on by briefly pressing the power button (). When the device is switched on, the green power diode lights up and there is an audible single sound signal. To switch off the receiver e.g. outside the heating season, hold down the power button for 3 seconds until there is an audible double sound signal, and the green power diode switches off, which means that the heating device has also been switched off.

### NOTE:

The wireless AURATON Libra R (transmitter) sold together with the AURATON Fornax wireless heating or air-conditioning device controller (receiver) in the AURATON Libra SET is already paired. Devices purchased separately require "pairing".

1. To initiate the pairing of AURATON Libra R (transmitter) with AURATON Fornax, press the right pairing button () - a single sound signal on the AURATON Fornax receiver, and hold it for at least 3 seconds, until the LED diode starts blinking green (double sound signal), then release the button.  
*The AURATON Fornax receiver will wait 120 seconds for pairing. After this time elapses, it will automatically return to normal operation.*
2. Press the **PROG** button on AURATON Libra R (transmitter) for 5 seconds until the broadcast symbol () lights up on the display. Release the button - AURATON Libra R transmits the pairing signal for 5 seconds.
3. Successful completion of pairing is signalled when the green LED diode on the AURATON Fornax receiver is no longer blinking, a single sound signal is heard, and the receiver returns to normal operation.

If there is a pairing error, please repeat steps 1 and 2. In case of further errors, unpair the device by **RESETTING** the AURATON Fornax receiver, see "**RESET - Unpairing a device paired with AURATON Fornax - wireless heating or air-conditioning device controller (receiver)**" and trying to pair the devices again.

### IMPORTANT:



The Auraton Fornax receiver can be paired with only one AURATON Libra R.

## Signalling the working status and data package reception

Each reception of radio transmission from a paired device is signalled by the AURATON Fornax receiver by a temporary alternating colour change of the LED diodes. When the relay is turned on, the LED diode is red and when the relay is turned off, the LED diode is green.

### **IMPORTANT:**

Pressing a button is signalled by a short sound signal.

## Unpairing AURATON Libra R - weekly, wireless thermostat paired with AURATON Fornax

1. To initiate the unpairing of AURATON Libra R (transmitter) paired with the AURATON Fornax receiver, press the left unpairing button (⚠) on the receiver and hold it for at least 3 seconds, until the LED diode starts blinking red, then release the button. The sound signals work in the same way as in the case of pairing, i.e. pressing a button is signalled by a short sound signal and after 3 seconds a double short sound signal is heard.  
*The AURATON Fornax receiver waits for the device to be unpaired for 120 seconds. After this time elapses, it will automatically return to normal operation.*
2. Press the **PROG** button on AURATON Libra R (transmitter) for 5 seconds until the broadcast symbol (📡) lights up on the display. Release the button.
3. Successful completion of unpairing is signalled when the red LED diode on the AURATON Fornax receiver is no longer blinking, a single sound signal is heard, and the receiver returns to normal operation.

If there is an unpairing error, please repeat steps 1 and 2. In case of further errors, unpair the paired device, see "RESET - Unpairing a device paired with AURATON Fornax - wireless heating or air-conditioning device controller (receiver)". patrz "RESET - Unpairing a device paired with AURATON

*Fornax - wireless heating or air-conditioning device controller (receiver)".*

## **RESET - Unpairing a device paired with AURATON Fornax - wireless heating or air-conditioning device (receiver)**

In order to unpair a device (e.g. a thermostat) paired with AURATON Fornax, simultaneously press and hold both pairing and unpairing buttons (▽ and ▲) for at least 5 seconds, until the LED diode starts to alternate blinking green - red. Then release both buttons. Sound signals: pressing the button, a short sound signal - after 5 seconds, a double short sound signal.

Successful completion of device unpairing is signalled after about 2 seconds, when the signalling changes to green, and then fades out for a short time.

### **NOTE:**

If you disconnect the AURATON Fornax receiver from the power supply after the RESET and then reconnect the power supply, the receiver will automatically enter the "pairing" mode for 120 seconds. A newly-purchased AURATON Fornax receiver (not purchased together with AURATON Libra R) without factory-paired devices will behave in the same way.

## **Resetting AURATON Libra R**

To perform a **reset**, remove the battery and wait until the data on the display disappears.

# Master reset of AURATON Libra R

**MASTER RESET** is performed by pressing and holding the  button and at the same time installing the batteries. This causes AURATON Libra R to return to its factory settings.



## **IMPORTANT:**

**All user-defined programs will be removed!**

## Configuration settings

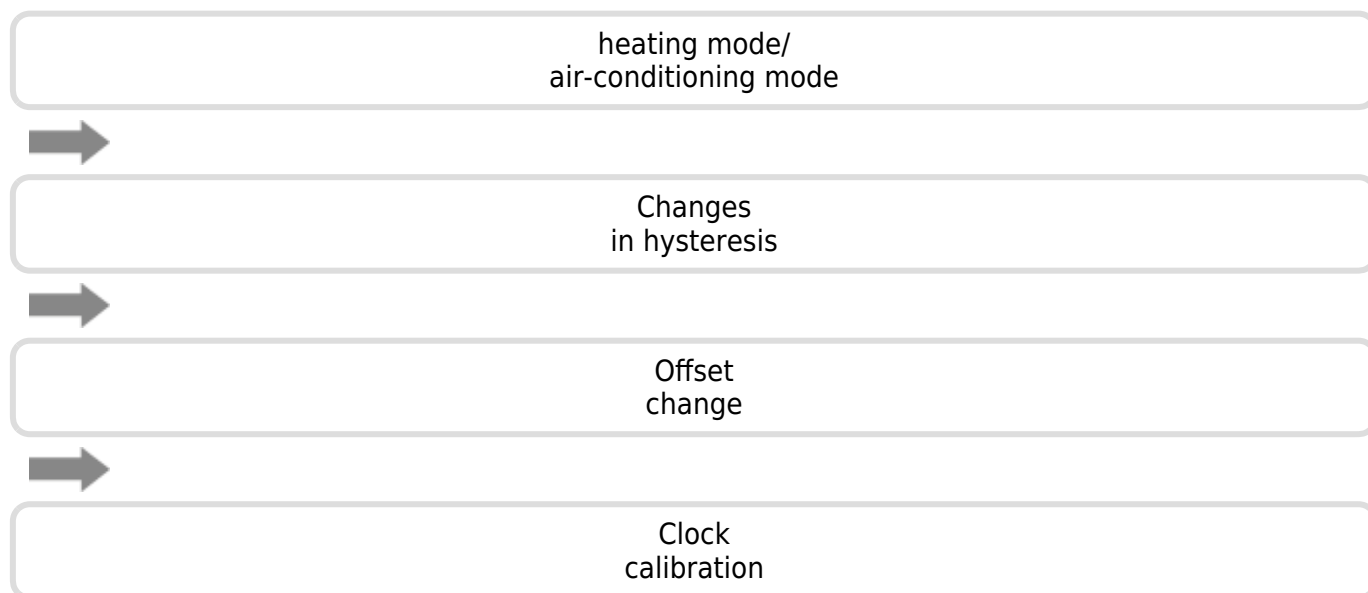
Configuration settings are set one after another:



To enter the edit mode of the configuration settings, hold the  and  buttons simultaneously for 3 seconds until the settings menu is displayed.

## Heating mode/air-conditioning mode

AURATON Libra R can work in two modes:



**Heating mode** (preset) - set it if you want AURATON Libra R to cooperate with heating devices.



**Air-conditioning mode** - set it if you want AURATON Libra R to cooperate with air-conditioning devices.

Turn the knob to the left or right to set the required mode. Confirm your choice by pressing the  button. AURATON Libra R will proceed to change the next parameter.

## Changes in hysteresis

Hysteresis is supposed to prevent too frequent activation of the actuator due to small temperature fluctuations.

*For example, in the case of **HI 2** hysteresis, when the temperature is set to 20 °C, the boiler will be switched on at 19.8 °C, and switched off at 20.2 °C. In the case of **HI 4** hysteresis, when the temperature is set to 20 °C, the boiler will be switched on at 19.6 °C, and switched off at 20.4 °C.*

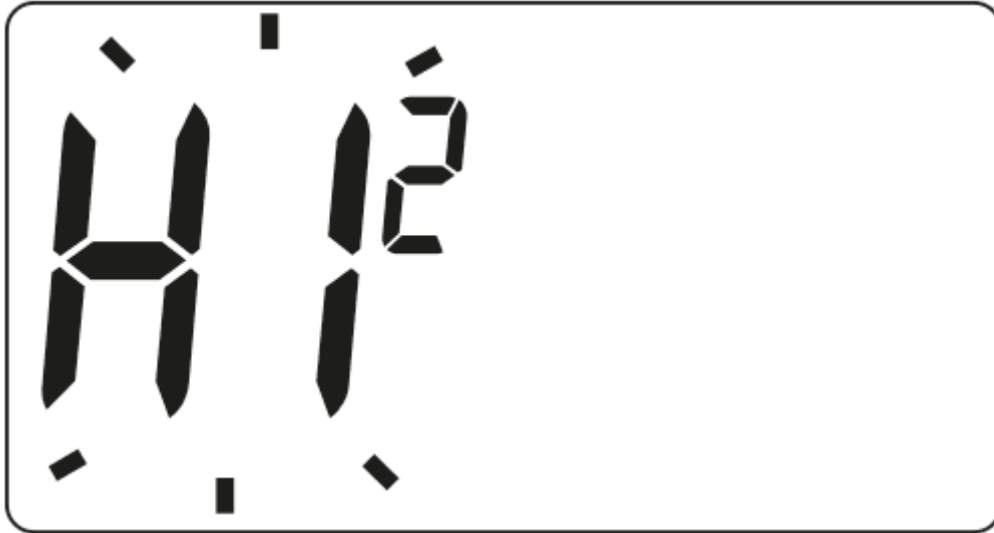

The hysteresis change mode is signaled by a flashing HI. Turn the knob to the left or right to set the desired hysteresis.

**HI 2** -  $\pm 0.2$  °C (preset),

**HI 4** -  $\pm 0.4$  °C,

**HI P** - PWM operating mode (see chapter "PWM operating mode").

Confirm your choice by pressing the  button. AURATON Libra R will proceed to change the next parameter.

## Offset change

Offset allows you to calibrate temperature indications with a tolerance of  $\pm 3$  °C. AURATON Libra R may for example show that the temperature in the room is 23 °C, while a regular room thermometer next to it may show 24 °C. Changing the offset by +1 degree, will make AURATON Libra R show the same temperature as the room thermometer.

The offset change mode is signaled by a flashing OFFS. By turning the knob to the left or right, you can set the desired value in the range from -3.0 to 3.0 (preset - 0.0). Confirm your choice by pressing the

 button. AURATON Libra R will return to the normal operating mode.



**IMPORTANT:**

If no button is pressed for 10 seconds while changing the configuration settings, AURATON Libra R will return to the normal operating mode.

**IMPORTANT:**

Pressing any function button for the first time always turns on the backlight, and then the function of a specific button.

## **Clock calibration**

This function is used to correct the clock indications in case of any deviations. If the clock is working incorrectly within a week, the extent of incorrect clock indications should be determined. This value should be entered in AURATON Libra R in the form of seconds.

**Example 1:**

After a week of operation, AURATON Libra R shows time accelerated by 1 minute and 20 seconds ( $60 + 20 = 80$ ). In this case you should slow down the clock by setting C -80.

**Example 2:**

After a week of operation, the clock in AURATON Libra R is 2 minutes slow ( $2 \times 60 = 120$ ). In this case you should speed up the clock by setting C 120.

**IMPORTANT:**

**The number of seconds should be determined after one week of operation of AURATON Libra R for the clock calibration function to work correctly (7 days = the number of seconds to be added or subtracted, maximum 294 seconds).**

**IMPORTANT:**

**If no button is pressed for 10 seconds while changing the configuration settings, AURATON Libra R will return to the normal operating mode.**

## PWM operating mode

(Pulse-Width Modulation)

By changing the hysteresis settings (chapter "Configuration settings"), you can turn on the PWM operating mode. In this mode, AURATON Libra R cyclically turns on the heating device in order to minimize temperature fluctuations. AURATON Libra R checks temperature rise times and temperature drop times.

Knowing these values makes AURATON Libra R turn on and off the heating device in appropriate cycles to maintain the temperature to the set value as close as possible.

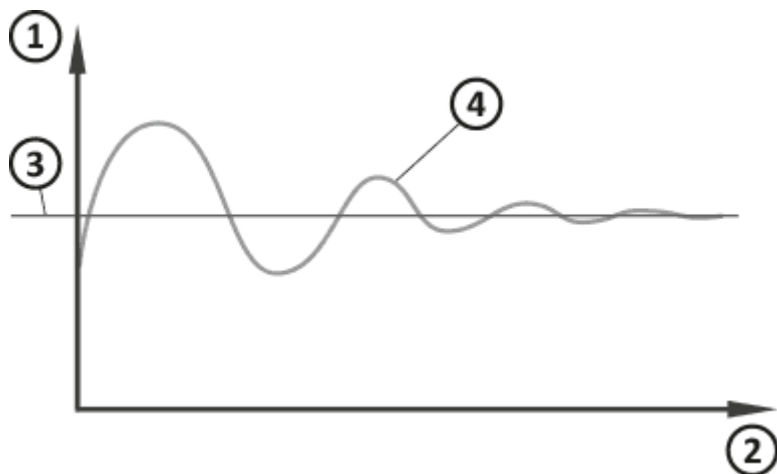

1. Temperature
2. Time
3. Set temperature
4. Room temperature

#### **IMPORTANT:**

**AURATON Libra R can turn on the heating device despite the fact that the temperature in the room is higher than the set temperature in the PWM mode. This is caused by the PWM algorithm aiming at maintaining the set temperature and anticipating the behavior of the thermal system.**



## **Special cases**

- When 3 consecutive transmissions are lost (after 15 minutes), AURATON Libra R (transmitter) will signal a malfunction on the AURATON Fornax receiver (the LED diode will alternate blinking red and green). Until the problem is resolved, the receiver will enter the stored on/off cycle from the last 24 hours.
- When the signal from AURATON Libra R returns, the error is cleared and the AURATON Fornax



receiver returns to normal operation.

## Additional remarks

- AURATON Libra R (transmitter) must be installed at least 1 metre away from the receiver (too strong a signal from the transmitter may cause interference).
- At least 30 seconds must elapse between switching the relay off and on again.
- Data from AURATON Libra R (transmitter) is transmitted to the AURATON Fornax receiver every time the ambient temperature changes by 0.2°C. If the temperature does not change, AURATON Libra R transmits control data every 5 minutes (this is signalled by a blinking orange diode on the receiver).
- In the event of a power failure, the AURATON Fornax receiver will switch off. After power is restored, the heating device will automatically switch on, and the AURATON Fornax receiver will wait for a signal from the paired AURATON Libra R (transmitter) no longer than 5 minutes after power is restored. After receiving the signal, the AURATON Fornax receiver will return to normal operation.
- Placing the AURATON Fornax receiver in a metal housing (e.g. mounting box, metal housing of a furnace) will cause interference with the operation of AURATON Libra R.
- You can turn control functions of AURATON Libra R (transmitter) on or off at any time (e.g. after the heating season) by briefly pressing the  button (for about 5 seconds) (AURATON Libra R will only show the current time and temperature of the room – there will be no “timeline”).
- Pressing any function button for the first time always turns on the backlight, and then the function of a specific button. When using the knob, each step keeps the backlight on.
- When programming any function, not pressing any button for 10 seconds is equivalent to pressing the  button.

## Cleaning and maintenance

- The outside part the device should be cleaned with a dry cloth. Do not use solvents (such as benzene, thinner or alcohol).
- Do not touch the device when your hands are wet. It may cause electric shock or serious damage to the device.

- Do not expose the device to excessive smoke or dust.
- Do not touch the screen with a sharp object.
- Keep the device away from liquids or moisture.

## Technical specifications

Power supply:	2 x AAA (2 x 1.5 V), alkaline
Working temperature range:	0 - 45 °C
Working status signaling:	LCD
Number of temperature levels:	2
Anti-freeze temperature:	7 °C
Temperature control range:	5 - 30 °C
Hysteresis:	±0.2 °C / ±0.4 °C / PWM
Working cycles:	Weekly programmable
Operation range:	in a typical building with standard wall construction - approx. 30 m; in open space - up to 300 m
Radio frequency:	868.850 MHz 869.000 MHz
Radio signal strength:	Up to 11 dBm
Level of security:	IP20
Dimensions [mm]:	90 x 90 x 36

## Disposing of the devices

The devices are marked with the crossed-out wheeled bin. According to European Directive 2012/19/EU and the Waste Electrical and Electronic Equipment Act, this kind of marking indicates that the equipment, after its operational life must not be disposed of together with other waste from households.

**The user shall return it to a collection point for electrical and electronic waste.**



Hereby, LARS Andrzej Szymanski declares that the radio equipment type AURATON Libra R is in compliance with Directive 2014/53/EU and 2011/65/EU. The full text of the EU declaration of conformity is available below in the download area.

---

**Contact and address of the manufacturer:**

LARS, ul. Świerkowa 14  
64-320 Niepruszewo  
[www.auraton.pl](http://www.auraton.pl)

---

## Download

- [User manual](#)
- [Declaration of conformity](#)